

AHRI Standard 885 with Addendum 1 (formerly ARI Standard 885)

2008 Standard for

Procedure for Estimating Occupied Space Sound Levels in the Application of Air Terminals and Air Outlets



Air-Conditioning, Heating,
and Refrigeration Institute

2111 Wilson Boulevard, Suite 500
Arlington, VA 22201, USA
www.ahrinet.org

PH 703.524.8800
FX 703.528.3816

AHRI STANDARD 885-2008
WITH ADDENDUM 1,

***PROCEDURE FOR ESTIMATING OCCUPIED SPACE
SOUND LEVELS IN THE APPLICATION OF AIR
TERMINALS AND AIR OUTLETS***

March 2011

Addendum 1 (dated March 2011) of AHRI Standard 885-2008, *Procedure for Estimating Occupied Space Sound Levels in the Application of Air Terminals and Air Outlets*, is provided as follows.

The particular additions are shown with shading and the deletions shown with ~~strikethroughs~~.

Table 8. Step-By-Step Calculation for the Procedural Example of Figure 6















SOUND PATH		Octave Band Mid Frequency, Hz					
PATH #	NAME	125	250	500	1000	2000	4000
1	Radiated and Induction Inlet						
	 Radiated and induction inlet L_w (from mfr's data, Table 5)	64	60	57	58	55	52
	 Environmental Adjustment Factor (6.2)	-2	-1	0	0	0	0
	 Ceiling/Space Effect, Table D14, Type 1 Ceiling	-16	-18	-20	-26	-31	-36
1	Radiated path L_p at receiver location	46	41	37	32	24	16
2	Duct Breakout Transmission Loss Path						
	 Terminal discharge L_w (from mfr's data, Table 5)	66	65	62	62	62	60
	 Environmental Adjustment Factor (6.2)	-2	-1	0	0	0	0
	 5.0 ft [1.5 m] lined rectangular duct 12 in x 12 in [300 mm x 300 mm], 1.0 in [25 mm] FG (D1.3.2) (See Note 1)	-1	-4	-10	-22	-20	-9
	 Duct transmission loss breakout noise, 0.03 in [0.7 mm] (D1.2.4)	-24 7	-27 10	-30 13	-33 16	-36 19	-41 24
	 Ceiling/Space Effect, Table D14, Type 1 Ceiling	-16	-18	-20	-26	-31	-36
2	Duct breakout transmission loss path L_p at receiver location	23 40	15 32	2 19	*	*	*
3	Distribution Duct Breakout Transmission loss Path						
	 Terminal discharge L_w (from mfr's data, Table 5)	66	65	62	62	62	60
	 Environmental Adjustment Factor (6.2)	-2	-1	0	0	0	0
	 10 ft [3 m] lined rectangular duct 12 in x 12 in [300 mm x 300 mm], 1.0 in [25 mm] FG (D1.3.2) (see Note 2)	-2	-6	-16	-40	-40	-25
	 Rectangular Tee attenuation entering branch duct (D1.4.4)	0	0	-1	-5	-7	-5
	 Branch power division 50% split (D1.1)	-3	-3	-3	-3	-3	-3
	 5.0 ft [1.5 m] unlined rectangular duct (D1.3)	0	0	0	0	0	0

Table 8. Step-By-Step Calculation for the Procedural Example of Figure 6 (continued)





























SOUND PATH		Octave Band Mid Frequency, Hz					
PATH #	NAME	125	250	500	1000	2000	4000
	 Duct breakout noise transmission loss, 0.03 in [0.7 mm] (D1.2.4) (12 ft in x 12 ft in [300 mm x 300 mm], 10 ft [3 m] long)	-2 4	-7 7	-10 10	-13 13	-16 16	-21 21
	 Ceiling/Space Effect, (D1.6) Table D14, Type 1 Ceiling	-16	-18	-20	-26	-31	-36
	 Distribution duct breakout transmission loss L_p at receiver location	19 39	10 30	12	*	*	*
	Flexible Duct Breakout Transmission Loss Path						
	 Terminal discharge L_w (from mfr's data, Table 5)	66	65	62	62	62	60
	 Environmental Adjustment Factor (6.2)	-2	-1	0	0	0	0
	 10 ft [3 m] lined rectangular duct 12 in x 12 in [300 mm x 300 mm], 1.0 in [25 mm] fiberglass D1.3.2 (see Note 2).	-2	-6	-16	-40	-40	-5
	 Rectangular Tee attenuation entering branch duct (D1.4.4)	0	0	-1	-5	-7	-5
	 Branch Power Division, 50% split, D1.1	-3	-3	-3	-3	-3	-3
	 5.0 ft [1.5 m] unlined rectangular duct (D1.3)	0	0	0	0	0	0
	 3.0 ft [0.9 m] lined 8 in [200 mm] diameter non-metallic flexible duct (D1.3.3)	-4	-7	-14	-15	-16	-8
	 Duct transmission loss, 8 in [200 mm] diameter non-metallic flexible duct (D1.2.2)	-8	-8	-8	-9	-10	-13
	 Ceiling/Space Effect, Table D14, Type 1 Ceiling.	-16	-18	-20	-26	-31	-36
	 Flexible duct breakout transmission loss path L_p at receiver location	31	22	0	*	*	*
	Discharge Path						
	 Terminal discharge L_w (from mfr's data, Table 5)	66	65	62	62	62	60
	 Environmental Adjustment Factor (6.2)	-2	-1	0	0	0	0
	 10 ft [3 m] lined rectangular duct, 12 in x 12 in [300 mm x 300 mm], 1.0 in [25 mm] fiberglass (D1.3.2) (see Note 2)	-2	-6	-16	-40	-40	-5
	 Rectangular Tee attenuation entering branch duct (D1.4.4)	0	0	-1	-5	-7	-5
	 Branch Power Division, 50% split (D1.1)	-3	-3	-3	-3	-3	-3
	 5.0 ft [1.5 m] unlined rectangular duct (D1.3)	0	0	0	0	0	0

Table 8. Step-By-Step Calculation for the Procedural Example of Figure 6 (continued)

SOUND PATH		Octave Band Mid Frequency, Hz					
PATH #	NAME	125	250	500	1000	2000	4000
	 5.0 ft [1.5 m] lined, 8 in [200 mm] diameter non-metallic flexible duct (D1.3.3)	-5	-10	-18	-19	-21	-12
	 End reflection Factor, 8.0 in [200 mm] diameter (D1.5)	-10	-5	-2	-1	0	0
	 Space Effect (5.0 ft [1.5 m], 2400 cu ft [67 m ³] room, Table D15)	-5	-6	-7	-8	-9	-10
	 Discharge L _p at receiver location	39	34	15	*	*	25
6	Outlet #1 Generated						
	 Outlet generated L _w (from mfr's data, Table 5)	40	43	46	46	44	42
	 Environmental Adjustment Factor (6.2)	-2	-1	0	0	0	0
	 Space Effect (5.0 ft [1.5 m], 2400 cu ft [67 m ³] room, Table D15)	-5	-6	-7	-8	-9	-10
	 Outlet generated L _p at receiver location	33	36	39	38	35	32
* Less than zero dB							
Note 1: For lined duct lengths up to 15 ft [4.5 m], take ½ duct insertion loss before calculating breakout transmission loss (max. 7.5 ft [2.3 m])							
Note 2: The maximum recommended lined duct attenuation in any octave band is 40 dB. See D1.3.2.							

The contributions of the six individual paths as shown on the acoustic model will be combined to obtain the total Sound Pressure Level, L_p at the receiver location. A similar calculation may be completed for various receiver locations (i.e., directly under the terminal or directly under the diffuser) in order to determine the acoustically critical receiver location.

The paths considered are:

1. Radiated and induction inlet
2. Duct **Transmission Loss** ~~Breakout~~
3. Distribution Duct **Transmission Loss** ~~Breakout~~
4. Flexible Duct **Transmission Loss** ~~Breakout~~
5. Discharge
6. Outlet #1 Generated

Table 9. Summary – Combination of Path Results Using Logarithmic Addition, dB

Path #	Description	Octave Band Mid Frequency, Hz					
		125	250	500	1000	2000	4000
1	Radiated and induction inlet path	46	41	37	32	24	16
2	Duct breakout transmission loss path	23 40	15 32	2 19	*	*	*
3	Distribution duct breakout transmission loss path	19 39	10 30	0 12	*	*	*
4	Flexible duct breakout transmission loss path	31	22	0	*	*	*
5	Discharge path	39	34	15	*	*	26 25
6	Outlet #1 generated path	33	36	39	38	35	32
Total L_p at receiver location check numbers here		47 48	43	41	39	35	33

* less than zero dB

Note: In this example it can be seen that the critical paths are casing radiated (Path #1), discharge (Path #5) and outlet generated (Path #6).

6.6 Additional Acoustic Models. Examples of the acoustic paths involved with single/dual duct terminal boxes and integral diffuser terminals are illustrated in Figures 7 and 8. The associated path factor calculations are tabulated in the summary calculation Tables 10 and 11 which list the source of the attenuation data.

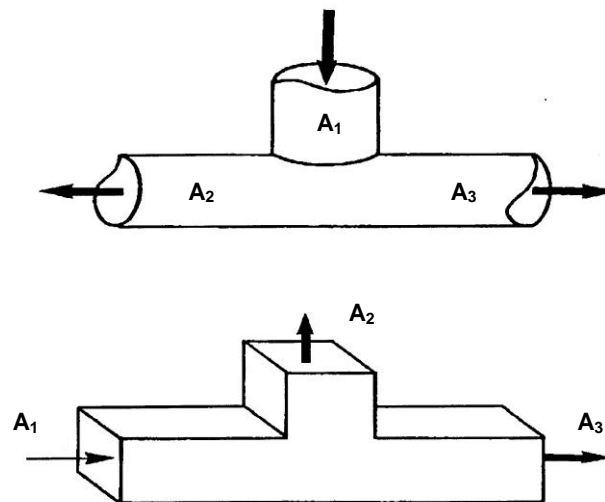

Figure D1. Branch Power Division

Table D2. Power Level Division at Branch Takeoffs			
B/T	Division, dB	B/T	Division, dB
1.00	0	0.100	10
0.80	1	0.080	11
0.63	2	0.063	12
0.50	3	0.050	13
0.40	4	0.040	14
0.32	5	0.032	15
0.25	6	0.025	16
0.20	7	0.020	17
0.16	8	0.016	18
0.12	9	0.012	19

Reprinted with permission of the American Society of Heating, Refrigerating & Air Conditioning Engineers, 2007 ASHRAE Handbook, HVAC Applications, Chapter 47, Table 22.

D1.2 *Duct Transmission Loss, Lined or Unlined* ∇_B . Airborne acoustic energy within a duct can be transmitted through the duct walls. This transmission loss path is termed Duct Breakout Transmission Loss.

The amount of acoustic energy transmitted is independent of external or internal duct insulation; the transmission loss is dependent on the duct geometry.

D1.2.1 *Circular Sheet Metal Duct.* ∇_B is calculated from the transmission loss characteristics of the duct and from the cross sectional & surface areas of the duct (see Figure D2.).

$$\nabla_B = TL_{out} - 10 \log (A_o/A_i) = L_{wi} - L_{wo}$$

Where:

- A_o = $\pi d_o L$ (Duct Outer Surface Area), in² [mm²]
- A_i = $\pi \frac{d_i^2}{4}$ (Duct Internal Cross Sectional Area), in² [mm²]
- d_i = Inside Diameter, in [mm]
- d_o = Outside Diameter, in [mm]
- L = Length, in [mm]
- L_{wi} = Sound Power Level at Duct Inlet, dB
- L_{wo} = Sound Power Level Breaking Out of Ductwall, dB
- TL_{out} = Transmission loss, dB

Values for TL_{out} are given in Table D3.

NOTE: The dimensions, d and L must be expressed in the same units. For single-wall ducts, $d_i = d_o$

Calculation Procedure and Table D3 are reprinted with permission of the American Society of Heating, Refrigerating & Air Conditioning Engineers, 2007 ASHRAE Handbook, HVAC Applications, Chapter 47.

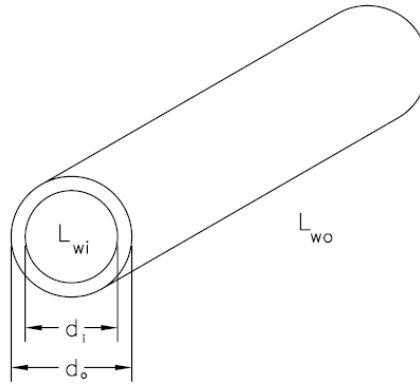

Figure D2. Circular Duct Breakout Transmission Loss

D1.2.2 Flexible Duct, Lined & Unlined ∇_B . Unlike circular sheet metal duct, radiated duct breakout transmission loss for flexible duct (according to 2007 ASHRAE Handbook, HVAC Applications) is not directly proportional to length. Most breakout transmission loss occurs in the first 1-2 ft [0.3 - 0.6 m] of the duct.

$$\nabla_B = L_{wi} - L_{wo}$$

Values for TL_{out} for flexible duct are given in Table D4.

The values shown in Table D4 are for 10 ft [3 m] of length but can be used for any length up to 10 ft [3 m].

Duct Diameter in [mm]	Duct Type in [mm]	Duct Length ft [m]	Octave Band Mid Frequency, Hz							
			63	125	250	500	1000	2000	4000	8000
8 in [200 mm]	0.022 in [0.55 mm] long seam	15 ft [4.5 m]	(45)	(53)	55	52	44	35	34	26
14 in [350 mm]	0.028 in [0.70 mm] long seam	15 ft [4.5 m]	(50)	60	54	36	34	31	25	38
22 in [550 mm]	0.034 in [0.85 mm] long seam	15 ft [4.5 m]	(47)	53	37	33	33	27	25	43
32 in [800 mm]	0.034 in [0.85 mm] long seam	15 ft [4.5 m]	(51)	46	26	26	24	22	38	43
8 in [200 mm]	0.022 in [0.55 mm] spiral wound	10 ft [3 m]	(48)	(64)	(75)	(72)	56	56	46	29
14 in [350 mm]	0.022 in [0.55 mm] spiral wound	10 ft [3 m]	(43)	(53)	55	33	34	35	25	40
26 in [650 mm]	0.028 in [0.70 mm] spiral wound	10 ft [3 m]	(45)	50	26	26	25	22	36	43
26 in [650 mm]	0.064 in [1.6 mm] spiral wound	10 ft [3 m]	(48)	(53)	36	32	32	28	41	36
32 in [800 mm]	0.034 in [0.85 mm] spiral wound	10 ft [3 m]	(43)	42	28	25	26	24	40	45
14 in [350 mm]	0.028 in [0.70 mm] long seam with two 90° elbows	15 ft [4.5 m] plus elbows	(50)	54	52	34	33	28	22	34

^a Parentheses indicate measurements in which background noise has produced a greater uncertainty than usual in the data. Parentheses are estimated values.

Duct Diameter in [mm]	Octave Band Mid Frequency, Hz							
	63	125	250	500	1000	2000	4000	8000
4-6 [100-150]	9	9	9	9	10	12	15	21
7-8 [170-200]	8	8	8	8	9	10	13	18
9 [205]	7	7	7	8	8	10	12	17
10 [250]	7	7	7	7	8	9	11	16
12-16 [300-400]	5	5	5	5	6	7	9	13

Reference: Compilation of Manufacturers Data

$dB = F \cdot 0.00179 + 10.79 - D \cdot (0.0000563 \cdot F + 0.41419)$ Where: F = octave band mid-frequency in Hz, and D = diameter in inches.

D1.2.3 Flat Oval Sheet Metal Duct, Lined & Unlined ∇_B . Duct Breakout transmission loss can be calculated from 2007 ASHRAE Handbook, HVAC Applications (see Figure D3.).

$$\nabla_B = TL_{out} - 10 \log (A_o/A_i) = L_{wi} - L_{wo}$$

Where:

A_o	=	$L [2(a_o - b_o) + \pi b]$	= Duct Outer Surface Area, in ² [mm ²]
A_i	=	$b(a_i - b_i) + \pi \frac{b^2}{4}$	= Duct Internal Cross Sectional Area, in ² [mm ²]
a_i	=	inner width, in [mm]	
a_o	=	Outer width, in [mm]	
b_i	=	inner height, in [mm]	
b_o	=	Outer height, in [mm]	
L	=	Length, in [mm]	
L_{wi}	=	Sound power level at inlet, dB	
L_{wo}	=	Sound power level at outlet, dB	
TL_{out}	=	Transmission loss, dB	

NOTE: The dimensions a, b and L must be in the same units. For single-wall ducts, $a_i = a_o$ and $b_i = b_o$.

Values of TL_{out} for flat oval duct are given in Table D5.

Calculation procedure reprinted with permission of the American Society of Heating, Refrigerating & Air Conditioning Engineers, 2007 ASHRAE Handbook, HVAC Applications, Chapter 47.

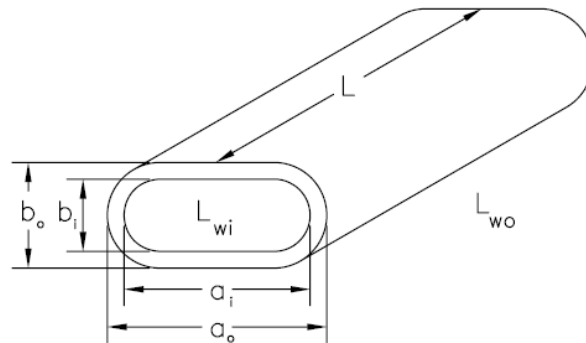

Figure D3. Flat Oval Duct Breakout Transmission Loss

D1.2.4 Rectangular Sheet Metal Duct, Lined & Unlined ∇_B . Duct Breakout transmission loss can be calculated from 2007 ASHRAE Handbook, HVAC Applications, Chapter 47 (see Figure D4.).

$$\nabla_B = TL_{out} - 10 \log (A_o/A_i) = L_{wi} - L_{wo}$$

Where:

A_o	=	$2L (a+b)$, in ² [mm ²]	= Duct Outer Surface area, in ² [mm ²]
A_i	=	$a \cdot b$, in ² [mm ²]	= Duct internal cross-sectional area, in ² [mm ²]
a_i	=	inner width, in [mm]	
a_o	=	Outer width, in [mm]	
b_i	=	outer width, in [mm]	
b_o	=	Outer height, in [mm]	

L = Length, in [mm]
 L_{wi} = Sound Power Level at duct inlet, dB
 L_{wo} = Sound Power Level, dB
 TL_{out} = Transmission loss, dB

NOTE: The dimensions a , b and L must be in the same units. For single-wall ducts, $a_i = a_o$ and $b_i = b_o$.

Values for TL_{out} for rectangular ducts are given in Table D6.

IMPORTANT

SAFETY DISCLAIMER

AHRI does not set safety standards and does not certify or guarantee the safety of any products, components or systems designed, tested, rated, installed or operated in accordance with this standard/guideline. It is strongly recommended that products be designed, constructed, assembled, installed and operated in accordance with nationally recognized safety standards and code requirements appropriate for products covered by this standard/guideline.

AHRI uses its best efforts to develop standards/guidelines employing state-of-the-art and accepted industry practices. AHRI does not certify or guarantee that any tests conducted under the standards/guidelines will not be non-hazardous or free from risk.

FOREWORD

This standard has been developed by the Air-Conditioning, Heating, and Refrigeration Institute (AHRI) for the purpose of establishing a uniform industry procedure for estimating Sound Pressure Levels in occupied spaces served by Air Terminals and/or air outlets.

AHRI Standard 885 establishes uniform application practices for making Air Terminal sound path attenuation calculations. Such standards and procedures will be of mutual benefit to designers, engineers, consultants, building owners and other users for the purpose of providing building design information to meet acoustic goals.

It should be recognized that the acoustical models and data used in AHRI Standard 885 are based on the best available data from both the American Society of Heating, Refrigerating and Air Conditioning Engineers (ASHRAE) and recognized industry sources.

Use of AHRI Standard 885 acoustical calculation procedures should provide a methodology for significantly improving the reliability of estimating the NC or RC levels in the occupied space over the more simplified acoustical models that have often been used in the past. The accuracy of all estimations depends on a significant body of experience accumulated with the use of this standard. AHRI Standard 885 has been in use for several years now, and has been proven to be a reliable method of sound estimation. Where the actual environment closely matches the assumptions, uncertainties of less than 5 dB in the estimated space sound level are commonly observed when these methods are employed.

AHRI Standard 880 does not provide for determination of Sound Power in the 63 Hz octave band. These products do not contribute significantly to the sound levels in occupied spaces in the 63 Hz octave band. The dominant source of sound levels in occupied spaces in the 63 Hz band is controlled by the primary air supply system. Since AHRI Standard 885 could be used to determine occupied space sound levels from the primary air supply system, data is provided where available in the 63 Hz octave band.

Note:

This standard supersedes ARI Standard 885-98.

The Relationships of AHRI Standard 880 and 885

Although this standard does not take into account space sound level contributions from the central system fan, ductwork upstream of the Air Terminal, equipment room machinery or exterior ambient, these often significant sound sources should be considered in the designer's work to achieve a complete estimate of room sound level.

AHRI Standard 880 "Air Terminals" provides industry agreed-upon methods for determining sound power ratings of Air Terminal and air distribution devices. These sound power ratings are published in manufacturers' data sheets.

AHRI Standard 885 provides industry agreed-upon methods to use AHRI Standard 880 sound ratings to estimate the sound levels which will occur in the conditioned, occupied space. It provides calculation methods to examine and compare sound sources and attenuation in the application of Air Terminals and air distribution devices.

What's New

This revision to AHRI Standard 885 includes several updated tables and methods, reflecting research conducted and reported since the preparation of the 1998 version of the Standard. An electronic calculation spreadsheet has been added to accompany the Standard. The ISO end reflection table has been replaced with one based on recent ASHRAE sponsored research.

TABLE OF CONTENTS

	PAGE
Section 1. Purpose	1
Section 2. Scope	1
Section 3. Definitions	1
Section 4. Symbols	4
Section 5. Description of Sound Estimating Method	6
Section 6. Calculation Procedures for Estimating Sound Levels in Occupied Spaces	11
Section 7. Use of Noise Criteria (NC) and Room Criteria (RC)	24
Section 8. Other Design Considerations to Meet Acoustic Goals	30
Section 9. Field Sound Diagnostics and Troubleshooting	33
Section 10. Conformance Conditions	36

TABLES

Table 1. Octave Band Mid Frequencies	3
Table 2. Environmental Adjustment Factor	5
Table 3. Source – Path – Receiver Process	7
Table 4. Sound Sources and Paths in Acoustic Model	13
Table 5. An Example from Typical Manufacturer’s Catalog	14
Table 6. Adjustment of Manufacturer’s Data	14
Table 7. Calculation – Fan-Powered Terminal or Induction Terminal	15
Table 8. Step-By-Step Calculation for the Procedural Example of Figure 6	17
Table 9. Summary – Combination of Path Results Using Logarithmic Addition	20
Table 10. Calculation – Single/Dual Duct Terminal	23

TABLES (continued)

Table 11.	Calculation – Integral Terminal.....	24
Table 12.	Subjective Effect of Changes in Sound Pressure Level, Broadband Sounds	24
Table 13.	Tabular Representation of NC Curves	30
Table 14.	Tabular Representation of RC Curves.....	30
Table 15.	Design Guidelines for HVAC System Noise in Unoccupied Spaces.....	31
Table 16.	Example: Determination of Maximum Allowable Sound Power.....	33

FIGURES

Figure 1.	Fan-Powered Terminal or Induction Terminal Acoustic Model	8
Figure 2.	Single, Double Duct Terminal Acoustic Model	9
Figure 3.	Integral Diffuser Terminal Acoustic Model	10
Figure 4.	Decibel Addition Example	11
Figure 5.	Fan-Powered Terminal or Induction Terminal – Summary Calculation, Sound Sources and Paths	13
Figure 6.	Fan-Powered Terminal or Induction Terminal – Sample Calculation Acoustic Model..	16
Figure 7.	Single/Dual Duct Terminal – Summary Calculation Sound Sources and Paths	21
Figure 8.	Integral Terminal – Summary Calculation Sound Sources and Paths.....	22
Figure 9.	Example of Steps to Assign an RC Rating to a Noise Spectrum	27
Figure 10.	NC Curves for Specifying the Design Level in Terms of the Maximum Permissible Sound Pressure Level for Each Frequency Band.....	28
Figure 11.	RC Curves for Specifying the Design Level in Terms of a Balanced Spectrum Shape..	29
Figure 12.	Suggested Prediction Locations in Small Rooms.....	34
Figure 13.	Suggested Small Room Microphone Locations if Low Frequency Standing Waves are Present.....	35

APPENDICES

Appendix A.	References – Normative	37
Appendix B.	References – Informative	37
Appendix C.	Environmental Adjustment Factor – Normative	38
Appendix D.	Sound Path Factors – Normative	39
Appendix E.	Typical Sound Attenuation Values – Normative.....	58

TABLES FOR APPENDICES

Table C1.	Environmental Adjustment Factor	38
Table D1.	Calculations for Attenuation Path Results.....	39
Table D2.	Power Level Division at Branch Takeoffs	40
Table D3.	TL _{out} versus Frequency for Various Circular Metal Ducts.....	42
Table D4.	Breakout versus Frequency for 10 ft [3 m] Sections of Non-Metallic Flexible Duct, Lined and Unlined	42
Table D5.	TL _{out} versus Frequency for Flat-Oval Ducts	44
Table D6.	TL _{out} versus Frequency for Rectangular Ducts	45
Table D7.	Insertion Loss for Lined Circular Ducts	46
Table D8.	Sound Insertion Loss/Attenuation in Straight Lined Sheet Metal Ducts of Rectangular Cross-Section	47
Table D9.	Lined Flexible Duct Insertion Loss	48
Table D10.	Attenuation of Lined Round Elbows When Preceding and Following at Least 3 Lined Duct Diameters of Duct Lining	49
Table D11.	Insertion Loss of Round Elbows	50
Table D12.	Insertion Loss of Unlined and Lined Elbows With/Without Turning Vanes.....	51
Table D13.	End Reflection Loss	52

TABLES FOR APPENDICES (continued)

Table D14.	Uncorrected Ceiling/Space Effect Attenuation Values	53
Table D15.	Ceiling/Space Effect Examples	54
Table D16.	Space Effect, Point Source	54
Table D17.	Room Sound Attenuation for an Outlet Array, 4 Outlets	55
Table D18.	Discharge Sound Effect Sample Calculations	56
Table D19.	Air Outlet Sound Estimates	57
Table E1.	Typical Sound Attenuation Values	58

FIGURES FOR APPENDICES

Figure D1.	Branch Power Division.....	40
Figure D2.	Circular Duct Breakout.....	41
Figure D3.	Flat Oval Duct Breakout.....	43
Figure D4.	Rectangular Duct Breakout	44
Figure D5.	Lined Circular Duct Insertion Loss	45
Figure D6.	Lined Flexible Duct Insertion Loss	49
Figure D7.	Duct Elbow and Tee Loss.....	50

PROCEDURE FOR ESTIMATING OCCUPIED SPACE SOUND LEVELS IN THE APPLICATION OF AIR TERMINALS AND AIR OUTLETS

Section 1. Purpose

1.1 *Purpose.* The purpose of this standard is to provide a consistent industry-accepted method for estimating Sound Pressure Levels in a conditioned occupied space for the application of Air Terminals and air outlets.

1.1.1 *Intent.* This standard is intended for the guidance of the industry, including manufacturers, engineers, installers, contractors and users.

1.1.2 *Review and Amendment.* This standard is subject to review and amendment as technology advances.

Section 2. Scope

2.1 *Scope.* This standard includes sound levels from most but not all components in the air distribution system. Air Terminals, air outlets and the low pressure ductwork which connects them are considered as sound sources and are the subject of this Standard.

This Standard does not make provisions to estimate space sound level contributions from the central system fan, ductwork upstream of the Air Terminal, equipment room machinery or exterior ambient sound.

This Standard is not currently applicable for underfloor radiated or discharge sound calculations.

AHRI Standard 880 does not provide for determination of sound power in the 63 Hz octave band. These products do not contribute significantly to the sound levels in occupied spaces in the 63 Hz octave band. The dominant source of sound levels in occupied spaces in the 63 Hz band is controlled by the primary air supply system. Since AHRI Standard 885 could be used to determine occupied space sound levels from the primary air supply system, data is provided where available in the 63 Hz octave band.

The methods described in this Standard can be used to identify acoustically critical paths in the system design. The design effects of inserting alternative components and changes in the system can be evaluated. The accuracy of evaluating the difference in sound pressure between two alternatives is greater than individual estimations.

Section 3. Definitions

All terms in this document follow the standard industry definitions in the current edition of *ASHRAE Terminology of Heating, Ventilation, Air Conditioning and Refrigeration* unless otherwise defined in this section.

3.1 *Air Terminal (Terminal).* A device that modulates the volume of air delivered to a conditioned space in response to a given load. The various types of Air Terminals are defined as follows:

3.1.1 *Bypass Terminal.* Air Terminal that diverts excess primary air to the return.

3.1.2 *Integral Diffuser Terminal.* Diffuser with the features of an Air Terminal.

3.1.3 *Dual Duct Terminal.* Air Terminal with two supply inlets that is used primarily for mixing cold and warm air streams at varying proportions.

- 3.1.4** *Induction Terminal.* Air Terminal that supplies varying proportions of primary and induced air.
- 3.1.5** *Parallel Flow Fan-Powered Terminal.* Air Terminal in which primary airflow is modulated in response to the cooling demand and in which the integral fan is operated to deliver induced air.
- 3.1.6** *Reheat Terminal.* Air Terminal that heats a single source of supply air.
- 3.1.7** *Series Flow Fan-Powered Terminal.* Air Terminal in which the primary airflow is modulated and mixed with induced air by a continuously operated integral fan to provide a relatively constant volume discharge.
- 3.1.8** *Single Duct Terminal.* Air Terminal supplied with one source of primary air.
- 3.2** *Ceiling/Space Effect.* Attenuation of Sound Power transmitted to an occupied space from above the ceiling as a result of the ceiling itself and the size of the space above the ceiling.
- 3.3** *Duct Breakout.* Sound associated with fan or airflow noise that radiates through the duct walls into the surrounding area.
- 3.4** *Environmental Adjustment Factor.* Difference between Sound Power Levels measured using a free field calibrated reference sound source and a reverberant field calibrated reference sound source. Sound Power measured in accordance with ASHRAE Standard 130 is based upon a free field calibrated reference sound source and the Environmental Adjustment Factors are used to correct these values to those using a reverberant field calibrated reference sound source because building spaces more closely represent a reverberant sound field.
- 3.5** *Equivalent Diameter.* Diameter of a circular equivalent of any duct for equal cross-sectional areas.
- 3.6** *Insertion Loss.* Reduction in observed Sound Pressure Level caused by installation of an Air Terminal, ductwork, or silencer.
- 3.7** *Noise.* Any unwanted sound.
- 3.7.1** *Background Noise.* Total noise that interferes with the measurement of the particular sound of interest which may include airborne sound, structure borne vibrations, and electrical noise in instruments.
- 3.7.2** *Generated Noise.* Noise produced from the flow of air past a restriction, rough wall, or other aerodynamic disturbance.
- 3.8** *Noise Criteria (NC).* Standard curves used to describe a spectrum of measured Sound Pressure Levels with a single number.
- 3.9** *Octave Band.* Frequency band with an upper band limit that is twice the frequency of the lower band limit. The mid frequency (center frequency) of an octave band is the geometric mean of its upper and lower band limits. The octave band mid frequencies of interest are listed in Table 1.
- 3.10** *Published Ratings.* A statement of the assigned values of those performance characteristics, under stated rating conditions, by which a unit may be chosen to fit an application. These values apply to all units of like nominal size and type produced by the same manufacturer. As used herein, the term Published Rating includes the rating of all performance characteristics shown on the unit or published in specifications, advertising or other literature controlled by the manufacturer, at stated rating conditions.

Octave Band	Mid Frequency, Hz
1	63
2	125
3	250
4	500
5	1000
6	2000
7	4000
8	8000

3.10.1 *Standard Rating.* A rating based on tests performed at standard rating conditions.

3.10.2 *Application Rating.* A rating based on tests performed at application rating conditions (other than standard rating conditions).

3.11 *Reverberation Room.* A test room with highly reflective surfaces that is designed to create a nearly homogeneous field of sound for the measurement of Sound Power Levels of a sound source.

3.12 *Room Criteria (RC).* Standard curves used to describe a well balanced spectrum of measured Sound Pressure Levels with a single number.

3.13 *“Shall” or “Should”.* “Shall” or “Should” shall be interpreted as follows:

3.13.1 *Shall.* Where “shall” or “shall not” is used for a provision specified, that provision is mandatory if compliance with the standard is claimed.

3.13.2 *Should.* “Should” is used to indicate provisions which are not mandatory, but which are desirable as good practice.

3.14 *Silencer.* Device used to attenuate sound transmitted through an HVAC system.

3.15 *Sound Attenuation.* The reduction of the intensity of sound as it travels from the source to a receiving location. Sound absorption is often involved as, for instance, in a lined duct. Spherical spreading and scattering are other attenuation mechanisms.

3.16 *Sound Power.* In a specified frequency band, the rate at which sound energy is radiated by a sound source, measured in watts.

3.16.1 *Sound Power - Discharge.* Sound Power transmitted from an Air Terminal outlet.

3.16.2 *Sound Power - Radiated.* Sound Power transmitted from an Air Terminal casing (plus induction port for fan-powered Air Terminals).

3.17 *Sound Power Level (L_w).* In a specified frequency band, ten times the common logarithm of the ratio of the Sound Power radiated by the sound source under test to the standard reference sound power of 10^{-12} Watt, dB.

3.18 *Sound Pressure.* In a specified frequency band, a fluctuating pressure superimposed on the static pressure by the presence of sound.



3.19 *Sound Pressure Level (L_p)*. In a specified frequency band, 20 times the common logarithm (base 10) of the ratio of the Sound Pressure radiated by the noise source under test to the standard reference pressure of 20 μ pascals, dB.

3.20 *Source-Path-Receiver Process*. The sound estimating method used in this Standard. In this process, a given Source of sound travels over a given Path to an occupied space where a Receiver hears the sound produced by the Source as in Table 3. Air Terminals and outlets are examples of sound Sources. The sound travels over one or more Paths where attenuation takes place. A person in the occupied space hears the noise at the Receiver location.

3.21 *Space Effect*. Attenuation of Sound Power entering a space as a result of the absorption properties of the space and the distance from the sound source to the receiver.

Section 4. Symbols

4.1 The symbols used within this Standard are included as an aid to the user. They are identified by the following:

- a. Sound source 
- b. Sound attenuation elements 
- c. Sound paths 

These symbols are used in pictorial acoustic models, tabulated acoustic paths, calculations and summary results as an aid to the user. They are identified by the following symbol definitions.

\textcircled{C} = *Casing Radiated and Induction Inlet Sound Power*. Sound transmitted through the casing or through the induction port of an Air Terminal to the surrounding space, typically, a ceiling plenum. \textcircled{C} is derived from \textcircled{C}_1 which is casing Radiated Sound Power obtained from manufacturer’s sound power data determined in accordance with AHRI Standard 880.

\textcircled{D} = *Discharge Sound Power*. Airborne Sound Power transmitted through the ductwork from the outlet of an Air Terminal device. \textcircled{D} is derived from \textcircled{D}_1 which is discharge Sound Power obtained from manufacturer’s sound power data determined in accordance with AHRI Standard 880.

\textcircled{O} = *Outlet Generated Sound Power*. Sound Power generated by and transmitted from an air outlet into the surrounding space; typically, the \textcircled{O} occupied space. is derived from \textcircled{O}_1 which is outlet generated Sound Power obtained from manufacturer’s sound power data determined in accordance with ASHRAE Standard 70 and ASHRAE Standard 130.

\textcircled{C} , \textcircled{D} and \textcircled{O} are calculated as follows:

$$\textcircled{C} = \textcircled{C}_1 - \textcircled{E}$$

$$\textcircled{D} = \textcircled{D}_1 - \textcircled{E}$$

$$\textcircled{O} = \textcircled{O}_1 - \textcircled{E}$$

where \textcircled{E} is the Environmental Adjustment Factor

 = *Environmental Adjustment Factor.* The Environmental Adjustment Factor is required in order to use the calculation procedures defined herein (refer to Appendix C).







Sound power measurement for Air Terminals is defined in AHRI Standard 880.

Real rooms at low frequencies are highly reverberant which causes the source to radiate less low frequency noise than if the source were operating in a free field (outdoors). For this reason, it is necessary to adjust manufacturers' sound power data before applying the data to estimate Sound Pressure in occupied spaces. Differential values between the two sources have been determined and must be subtracted from manufacturers' data as a part of the calculation. The values are shown in Table 2.

Table 2. Environmental Adjustment Factor	
Octave Band Center Frequency, Hz	Environmental Adjustment Factor, dB
63	4
125	2
250	1
500	0
1000	0
2000	0
4000	0
8000	0
Note: This reflects the results of ASHRAE RP755, <i>Sound Transmission through Ceilings from Air Terminal Devices in the Plenum.</i>	

A more detailed explanation of the environmental adjustment factor is found in Appendix C.

4.2 Sound Path.

-  = *Duct Breakout Transmission Loss, Lined or Unlined.* Difference between Octave Band Sound Power Level entering a duct section and the Sound Power radiated by the section of duct.
-  = *Flow Division Noise Reduction.* Reduction in octave band Sound Power Level along a path, attributable to the division of air flow.
-  = *Duct Insertion Loss.* Difference between the octave band airborne Sound Power entering a duct section and the airborne Sound Power leaving the duct section.
-  = *Manufacturer's Attenuation Element.* Difference between the airborne octave band Sound Power Level entering the manufacturer's attenuation element and the Sound Power leaving the element.
-  = *Ceiling/Space Effect.* Difference between the octave band Sound Power Level from the source located in the plenum/ceiling cavity and the Sound Pressure received in the occupied space.
-  = *Duct End Reflection Loss.* The sudden area change at the exit of an integral terminal unit or outlet can reflect significant low frequency energy back into the attached ductwork. The end reflection loss accounts for this. It is the difference between the octave band Sound Power incident on a duct end and the Sound Power transmitted out of the end of a duct.

 = *Space Effect*. Difference between the octave band Sound Power Level entering the occupied space and the resulting octave band Sound Pressure Level at a specific point in an occupied space.





 = $L_w - L_p$

where:

L_w = Sound Power Level
 L_p = Sound Pressure Level

 = *Duct Elbow and Tee Loss*. Difference between the airborne octave band Sound Power Level entering a lined or unlined elbow or tee duct connection and the airborne Sound Power leaving the elbow or tee when the elbow or tee is coupled with at least three duct diameters of lined duct upstream and/or downstream of the elbow or tee.

4.3 Receiver Symbols and Definitions.

-  = Resultant Sound Pressure Level at the receiver calculated along Path 1.
-  = Resultant Sound Pressure Level at the receiver calculated along Path 2.
-  = Resultant Sound Pressure Level at the receiver calculated along Path N.
-  = Resultant logarithmic sum of Sound Pressure Levels at the receiver from all sound paths for a specific Octave Band.

Section 5. Description of Sound Estimating Method

5.1 Introduction. The sound estimating method used in this standard is based on a simple process called Source-Path-Receiver. A given *Source* of sound travels over a given *Path* to an occupied space where a *Receiver* hears the sound produced by the *Source* as in Table 3.

5.2 Outline of the Sound Pressure Estimating Procedure. This standard estimates space Sound Pressure Levels when the acoustic performance of Air Terminals and/or outlets is known. A second use of the standard is to estimate the maximum permissible Sound Power Level from a terminal device so that a selected acoustical design criteria (NC or RC) will not be exceeded.

Four steps are required to estimate Sound Pressure Levels by Octave Band:

- 5.2.1** Obtain Air Terminal or outlet Sound Power Levels at the specific unit operating point(s). Source: Manufacturer’s Data.
- 5.2.2** Identify the sound paths to be evaluated. Source: Acoustic Model.
- 5.2.3** Determine the attenuation path factors for each path. Source: Appendix D, Standard 885.
- 5.2.4** Logarithmically add the acoustic contribution from each sound path to determine overall Sound Pressure Level.





5.3 Acoustical Models. Acoustical models for each of the major Air Terminal/distribution applications are shown in Figures 1, 2 and 3 which follow. The models identify receiver sound paths and graphically illustrate the process of sound level prediction.

5.4 Upstream Sound Sources. This standard does not take into consideration sound breaking out of the inlet ducts to Air Terminal devices as shown (by the dashed-line arrow) in the upstream duct breakout radiated path in Figure 1. Sound emitted from this element can come from these sources:

1. The airborne sound from the system central fan;
2. Airborne regenerated sound from upstream takeoffs and fittings;
3. Sound traveling upstream from the terminal.

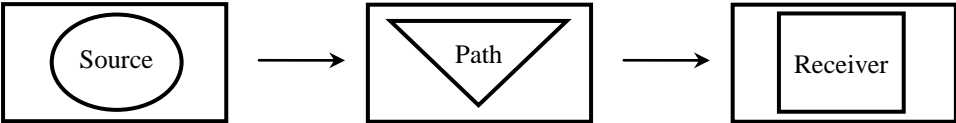
At the present time, catalog data is not available for sound traveling upstream from the Air Terminal. It is difficult to estimate because of the wide variety of fittings used.

If the designer feels upstream noise might be significant (e.g., where a terminal is mounted close to the supply fan), it is recommended that hard duct be used or that flex duct be lagged.

Table 3. Source – Path – Receiver Process			
Process			
Description	Air Terminals and outlets are examples of <i>sound Sources</i> .	The sound travels over one or more <i>Paths</i> where attenuation takes place.	A person in the occupied spaces who hears the sound at the receiver location.
Symbols Used in this Standard	 A circle denotes a sound Source. The letter defines which Source.	 A triangle denotes an attenuation on the sound path. The letter defines the type of attenuation	 A square denotes a sound Receiver. The number defines the sound path being considered.
Nature of Data	Octave band Sound Power Level (L_w) of Source in decibels (dB).	Octave band Path Attenuation Sound reduction due to ducting, ceiling tile, etc.	Octave band Sound Pressure Level (L_p) at receiver location. Often evaluated as Noise Criteria (NC) or Room Criteria (RC).
Sources of Data	Manufacturer's data tested in accordance with: <ul style="list-style-type: none"> • Air Terminals ASHRAE 130 • Air outlets ASHRAE 70 	AHRI Standard 885, Appendix D.	Calculated by procedures in AHRI Standard 885.

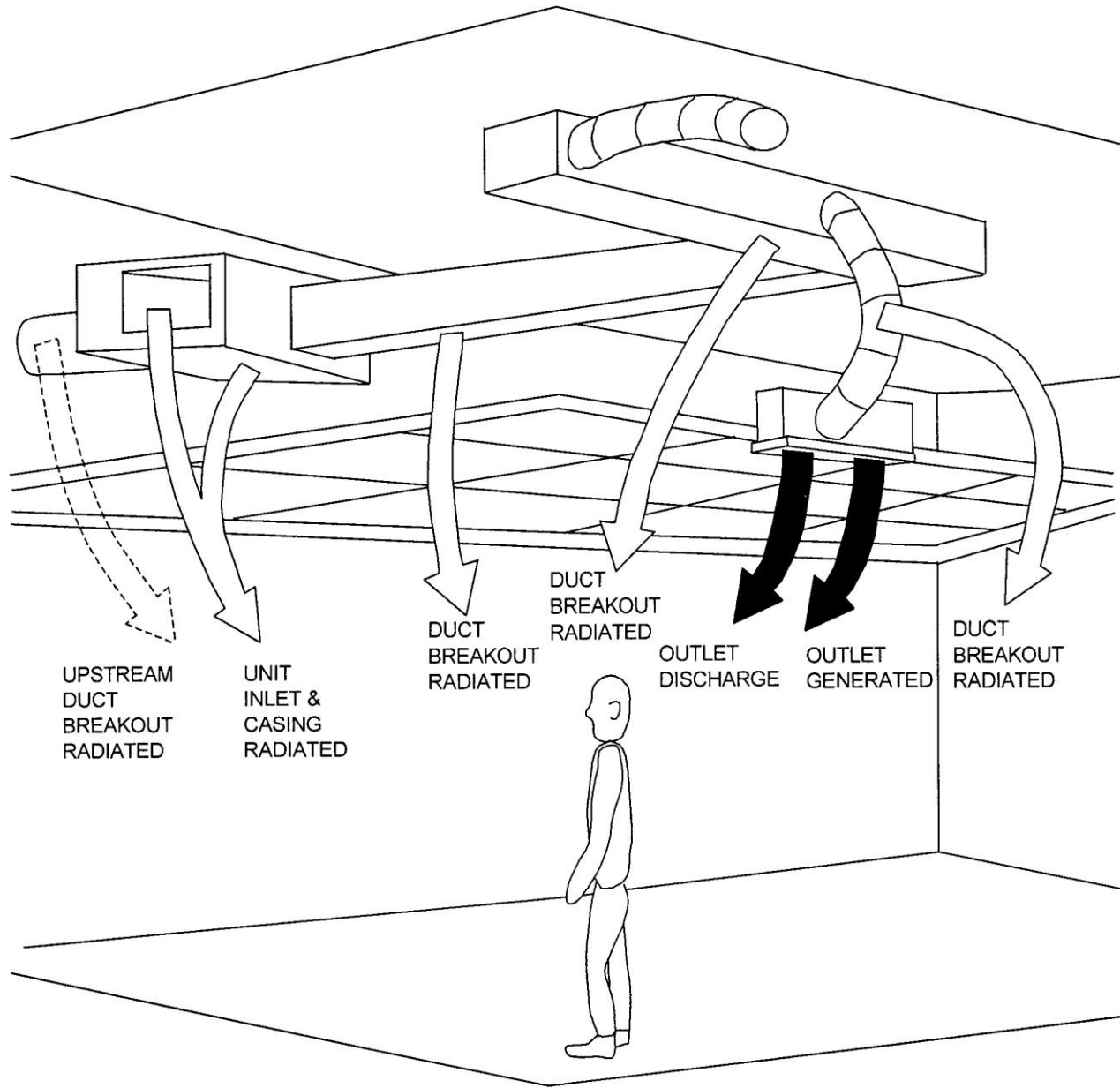

Figure 1. Fan-Powered Terminal or Induction Terminal Acoustic Model

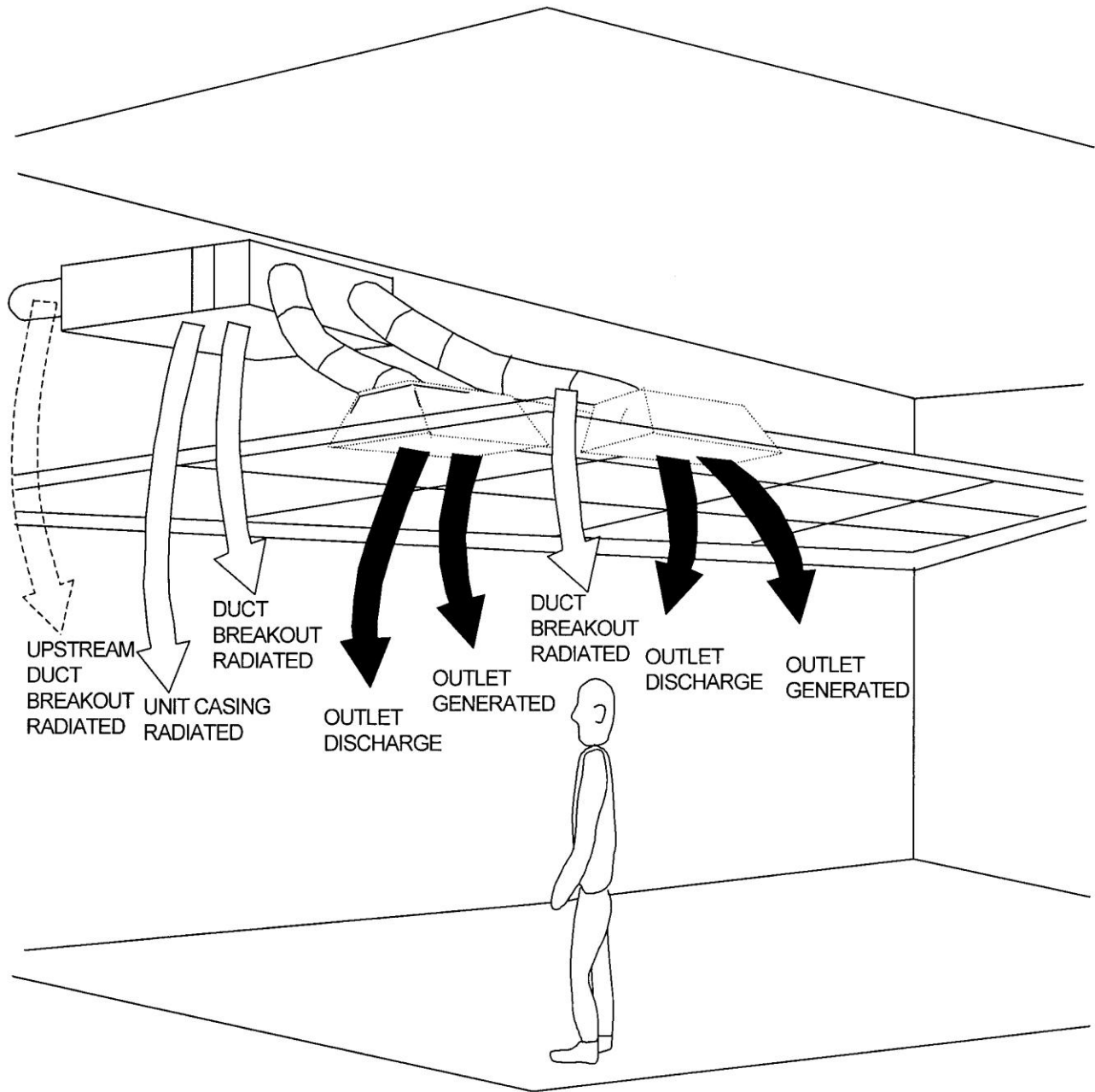

Figure 2. Single, Double Duct Terminal Acoustic Model

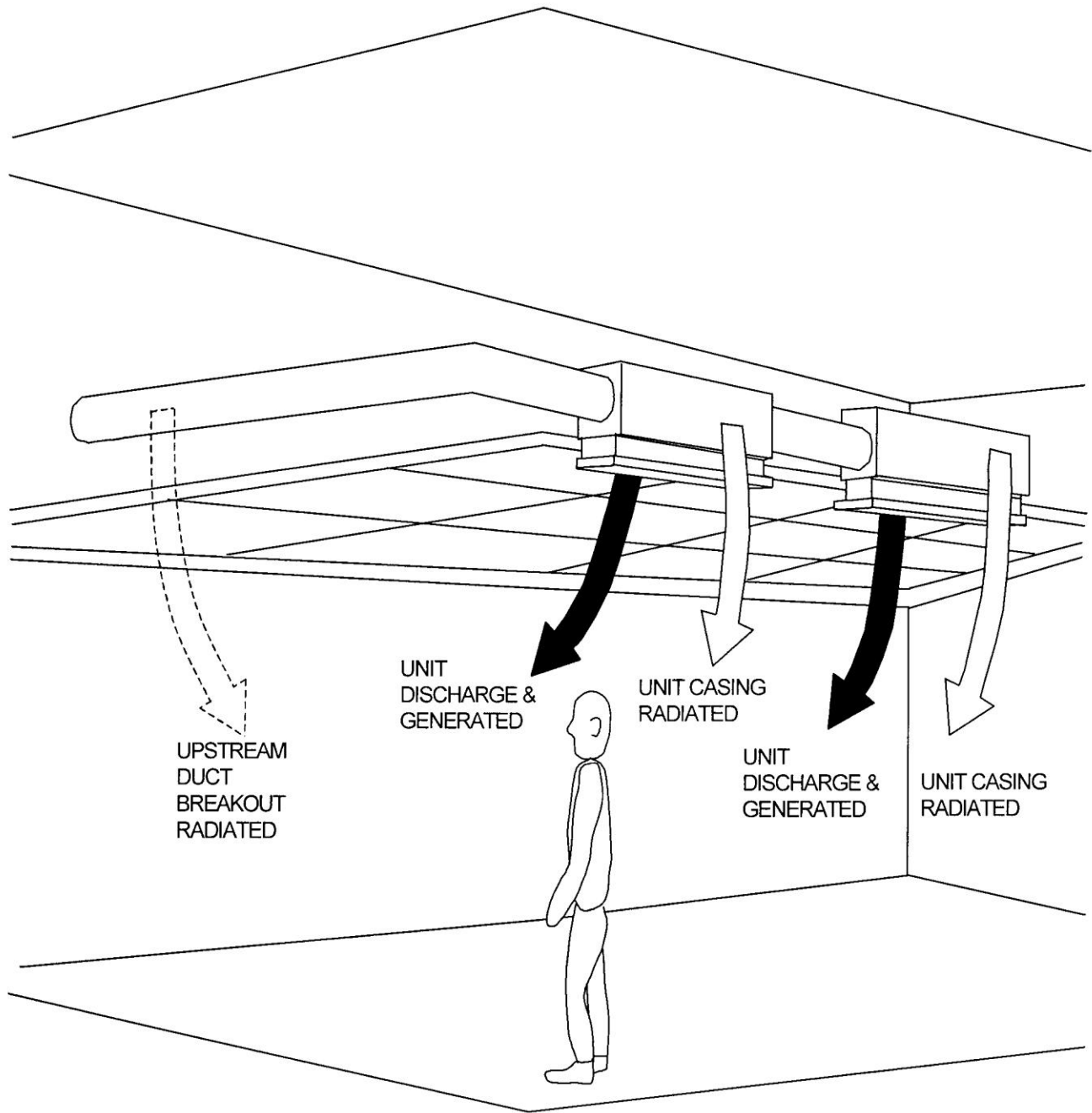

Figure 3. Integral Diffuser Terminal Acoustic Model

Section 6. Calculation Procedures for Estimating Sound Levels in Occupied Spaces

6.1 Introduction. Figures 5, 6 and 7 display the source paths which must be evaluated to enable the net sound level in a conditioned space to be estimated. Each path is broken into individual source and attenuation segments. Source sound levels are obtained from the terminal or outlet manufacturer's data and path factor attenuation is determined according to the procedures which follow.

The designer must select paths from the acoustic models which match the particular applications of the job. For example, single and dual duct terminals are applied with multiple and individual flex duct connections. The Air Terminals are also applied with extended discharge plenums and lateral take-offs. Each application will require a specific acoustic model.

If the designer knows which paths are most significant, the calculation procedure can be simplified. Otherwise, it is recommended that all paths of the specific acoustic model be evaluated until the designer is comfortable with a simplified model.

After experience is gained in using Standard 885, the dominant sound source(s) and path(s) will become apparent. In drawing the specific acoustic model for the application it is recommended that the receiver location be placed directly under the dominant sound source and 5.0 ft [1.5 m] from the floor. Where more than one significant sound source is possible, an additional model should be drawn for these sources, again with the receiver location directly under the source and 5.0 ft [1.5m] from the floor. An illustration of these positions is shown in Figure 11.

6.2 Environmental Adjustment Factor. As explained in Section 3, it is necessary to reference the source Sound Power Levels to a reverberant sound source before proceeding with the calculation. Using the values given in Section 3, the procedure can be illustrated as shown in Tables 5 and 6, using data from an actual situation. The following tabulation contains manufacturers' sound power level data, taken in accordance with ASHRAE Standard 130 and ASHRAE Standard 70.

6.3 Decibel Addition Example. To add two dB values together, a simplified method may be used, as shown in the following example, Figure 4. It can be seen that differences of 10 dB make the lower value insignificant, while the sum of two equal values results in an increase of 3 dB.

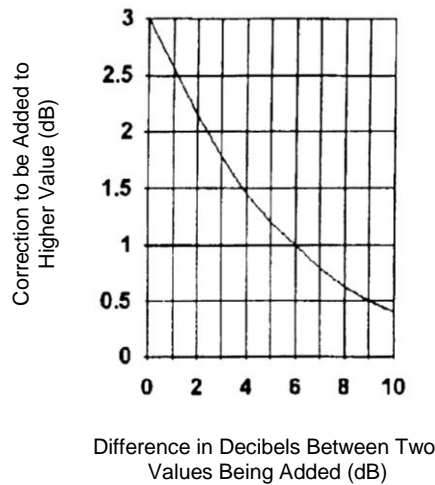

Figure 4. Decibel Addition Example

To add two decibel values:

80 dB
+74 dB

Difference in values: 6 dB

From chart: Add 1.0 dB to higher value:

$$\begin{array}{r} 80 \text{ dB} \\ +1 \text{ dB} \\ \hline 81 \text{ dB} \end{array}$$

6.4 *Example of a Specific Acoustic Model.* To demonstrate the procedure, a fan powered box/induction unit acoustic model (Figure 5) was selected and the specific sound paths defined.

Figure 5 outlines six sound paths:

Receiver	Path
1	Radiated and Induction Inlet
2	Duct Breakout
3	Distribution Duct Breakout
4	Flexible Duct Breakout
5	Discharge
6	Outlet I Generated Sound

In an application of this type, there will often be several other diffusers or outlets not shown in Figure 5.

Table 4 then lists each sound path and its components which may be involved in a fan powered terminal or induction unit installation and provides direction for calculation of each receiver value. (An explanation of the symbols used in the calculation procedure can be found in Section 4.)

Each of the sound path attenuation factors is now determined using the detailed data of Section 7.

The summary or net sound calculation can then be made by subtracting the path attenuation factors from the sound source and logarithmically summing the path results.

For the fan powered terminal or induction unit in our example, the path calculations are as follows: (Ref. Figure 5.)

Sound Summary Calculation

$$L_{PT} = \boxed{1} \oplus \boxed{2} \oplus \boxed{3} \oplus \boxed{4} \oplus \boxed{5} \oplus \boxed{6}$$

Where \oplus is log addition as defined below:

$$\boxed{L_{PT}} = 10 \text{ Log} \left[10\left(\frac{\boxed{1}}{10}\right) + 10\left(\frac{\boxed{2}}{10}\right) + \dots + 10\left(\frac{\boxed{n}}{10}\right) \right]$$

Where n = the number of paths being added logarithmically.

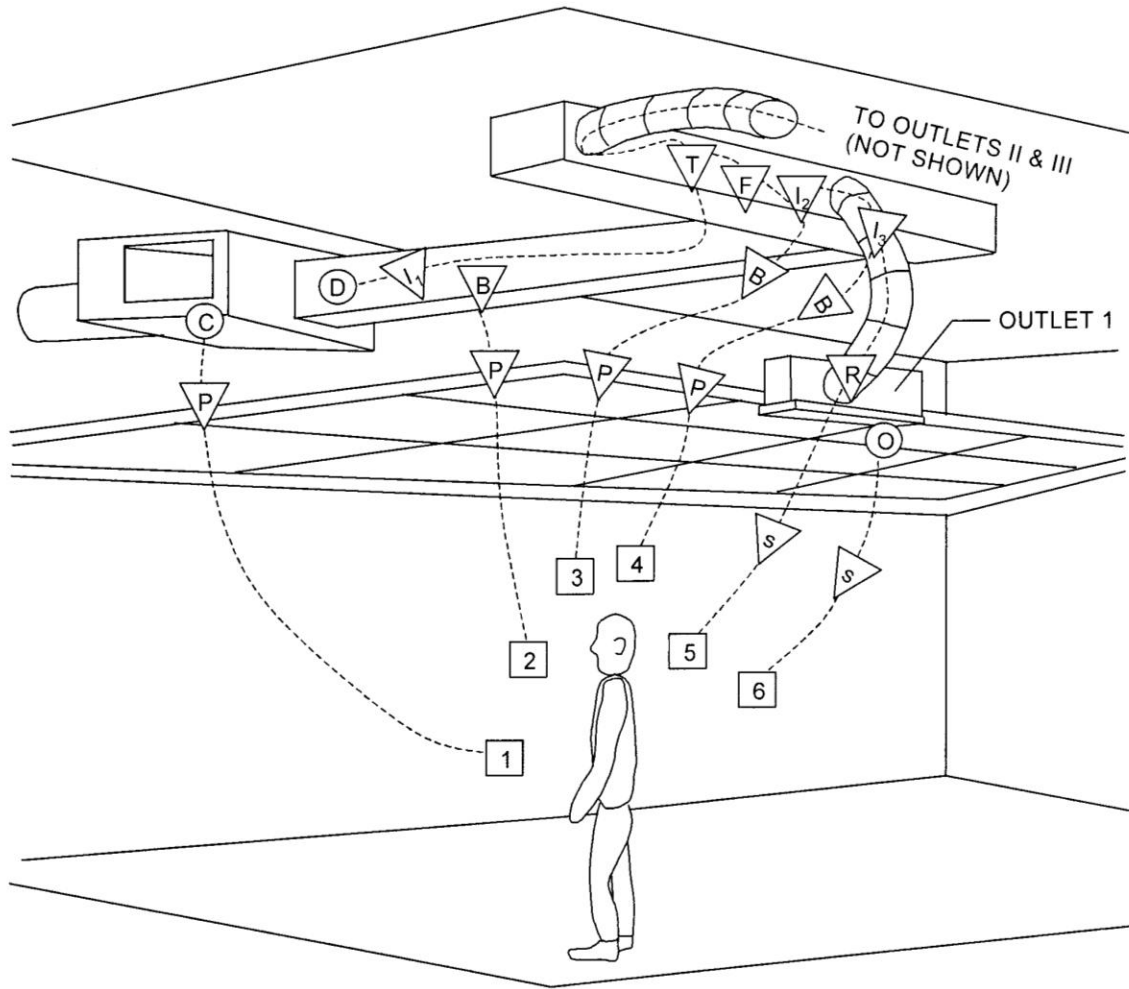

Figure 5. Fan-Powered Terminal or Induction Terminal – Summary Calculation, Sound Sources and Paths

Table 4. Sound Sources and Paths in Acoustic Model (Figure 5)		
Sound Source	Path Attenuation Factor	Sound Receiver/Path
(C)	P	= 1
(D)	I ₁ - B - P	= 2
(D)	I ₁ - T - F - I ₂ - B - P	= 3
(D)	I ₁ - T - F - I ₂ - I ₃ - B - P	= 4
(D)	I ₁ - T - F - I ₂ - I ₃ - R - S	= 5
(O)	S	= 6

Table 5. An Example from Typical Manufacturer's Catalog, dB							
Source	Description	Octave Band Mid Frequency, Hz					
		125	250	500	1000	2000	4000
(C ₁)	Unit Casing Radiated and Induction Inlet	64	60	57	58	55	52
(D ₁)	Unit Discharge	66	65	62	62	62	60
(O ₁)	Outlet Generated	40	43	46	46	44	42

The Environmental Adjustment Factor $\diamond E$ is then subtracted from the Sound Power Level obtained with the free field calibration. Table 6 provides the calculation.

Table 6. Adjustment of Manufacturer's Data, dB							
Description of Sound Source	Symbol	Octave Band Mid Frequency, Hz					
		125	250	500	1000	2000	4000
Induction Inlet & Terminal Radiated Sound, L _w	(C ₁)	64	60	57	58	55	52
	$\diamond E$	-2	-1	0	0	0	0
	(C)	62	59	57	58	55	52
Terminal Discharge Sound, L _w	(D ₁)	66	65	62	62	62	60
	$\diamond E$	-2	-1	0	0	0	0
	(D)	64	64	62	62	62	60
Outlet Generated Sound, L _w	(O ₁)	40	43	46	46	44	42
	$\diamond E$	-2	-1	0	0	0	0
	(O)	38	42	46	46	44	42

Where (C₁), (D₁) and (O₁) are obtained from manufacturer's data. (C), (D) and (O) are used as entries to the following path calculations. Refer to Appendix C for more information.

Table 7 provides a list of six sound paths with the required calculations for the fan powered terminal example.

6.5 Complete Sample Calculation. The entire path calculation is now made for the fan-powered terminal example.

The acoustic model in Figure 5 is shown again as Figure 6 with specific dimensions for the example. Using the example power level data and reference data from the calculation sources in Appendix D, the complete calculation is made as shown in Table 8.

Table 7. Calculation – Fan-Powered Terminal or Induction Terminal (Ref: Figure 5. Acoustic Model)

Sound Path		Sound Source	Path Attenuation Calculation		
Path Number	Name		Symbol	Name	Find Calculation Method in
1	Radiated and Induction Inlet	(C)	P	Ceiling/Space Effect	D1.6
2	Duct Breakout Sound	(D)	I ₁	Duct Insertion Loss	D1.3
			B	Duct Breakout Transmission Loss	D1.2
			P	Ceiling/Space Effect	D1.6
3	Distribution Duct Breakout	(D)	I ₁	Duct Insertion Loss	D1.3
			T	Duct Elbow & Tee Loss	D1.4.4
			F	Branch Power Division	D1.1
			I ₂	Duct Insertion Loss	D1.3
			I ₂	Duct Breakout Transmission Loss	D1.2
			B	Ceiling/Space Effect	D1.6
			P		
4	Flexible Duct Breakout	(D)	I ₁	Duct Insertion Loss	D1.3
			T	Duct Elbow & Tee Loss	D1.4.4
			F	Branch Power Division	D1.1
			I ₂	Duct Insertion Loss	D1.3
			I ₂	Duct Insertion Loss	D1.3
			I ₃	Duct Breakout Transmission Loss	D1.2
			B	Ceiling/Space Effect	D1.6
			P		
5	Discharge Sound	(D)	I ₁	Duct Insertion Loss	D1.3
			T	Elbow & Tee Loss	D1.4.4
			F	Branch Power Division	D1.1
			I ₂	Duct Insertion Loss	D1.3
			I ₂	Duct Breakout Transmission Loss	D1.3
			I ₃	End Reflection Factor	D1.5
			R	Space Effect	D1.7
			S		
6	Outlet Generated Sound	(O)	S	Space Effect	D1.7

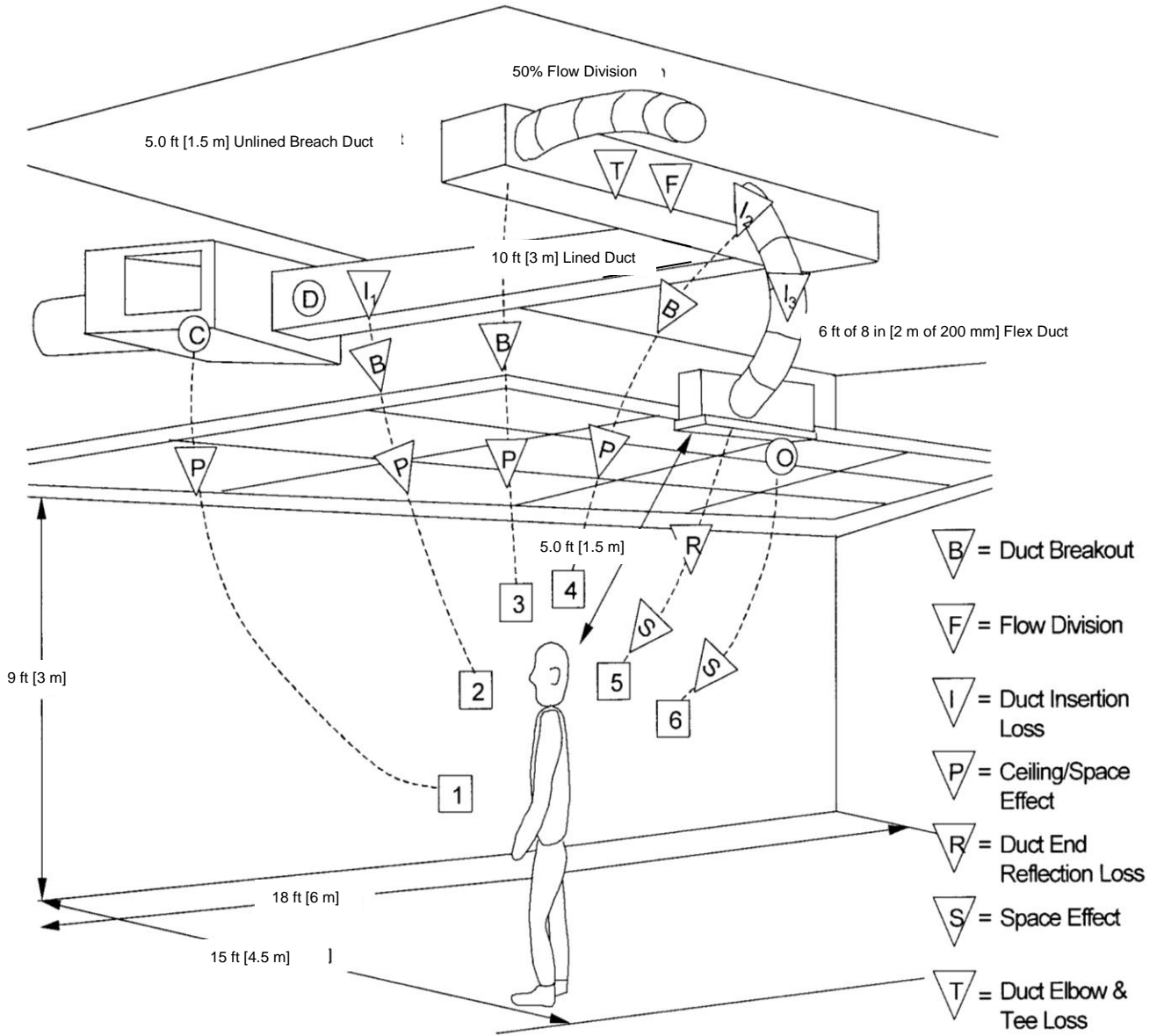

Figure 6. Fan-Powered Terminal or Induction Terminal – Sample Calculation Acoustic Model

Table 8. Step-By-Step Calculation for the Procedural Example of Figure 6















SOUND PATH		Octave Band Mid Frequency, Hz					
PATH #	NAME	125	250	500	1000	2000	4000
1	Radiated and Induction Inlet						
	 Radiated and induction inlet L_w (from mfr's data, Table 5)	64	60	57	58	55	52
	 Environmental Adjustment Factor (6.2)	-2	-1	0	0	0	0
	 Ceiling/Space Effect, Table D14, Type 1 Ceiling	-16	-18	-20	-26	-31	-36
1	Radiated path L_p at receiver location	46	41	37	32	24	16
2	Duct Breakout Path						
	 Terminal discharge L_w (from mfr's data, Table 5)	66	65	62	62	62	60
	 Environmental Adjustment Factor (6.2)	-2	-1	0	0	0	0
	 5.0 ft [1.5 m] lined rectangular duct 12 in x 12 in [300 mm x 300 mm], 1.0 in [25 mm] FG (D1.3.2) (See Note 1)	-1	-4	-10	-22	-20	-9
	 Duct breakout noise, 0.03 in [0.7 mm] (D1.2.4)	-24	-27	-30	-33	-36	-41
	 Ceiling/Space Effect, Table D14, Type 1 Ceiling	-16	-18	-20	-26	-31	-36
2	Duct breakout path L_p at receiver location	23	15	2	*	*	*
3	Distribution Duct Breakout						
	 Terminal discharge L_w (from mfr's data, Table 5)	66	65	62	62	62	60
	 Environmental Adjustment Factor (6.2)	-2	-1	0	0	0	0
	 10 ft [3 m] lined rectangular duct 12 in x 12 in [300 mm x 300 mm], 1.0 in [25 mm] FG (D1.3.2) (see Note 2)	-2	-6	-16	-40	-40	-25
	 Rectangular Tee attenuation entering branch duct (D1.4.4)	0	0	-1	-5	-7	-5
	 Branch power division 50% split (D1.1)	-3	-3	-3	-3	-3	-3
	 5.0 ft [1.5 m] unlined rectangular duct (D1.3)	0	0	0	0	0	0





























Table 8. Step-By-Step Calculation for the Procedural Example of Figure 6 (continued)							
SOUND PATH		Octave Band Mid Frequency, Hz					
PATH #	NAME	125	250	500	1000	2000	4000
	 Duct breakout noise , 0.03 in [0.7 mm] (D1.2.4) (12 ft x 12 ft [300 mm x 300 mm], 10 ft [3 m] long)	-24	-27	-30	-33	-36	-41
	 Ceiling/Space Effect, (D1.6) Table D14, Type 1 Ceiling	-16	-18	-20	-26	-31	-36
	 Distribution duct breakout L_p at receiver location	19	10	*	*	*	*
	Flexible Duct Breakout Path						
	 Terminal discharge L_w (from mfr's data, Table 5)	66	65	62	62	62	60
	 Environmental Adjustment Factor (6.2)	-2	-1	0	0	0	0
	 10 ft [3 m] lined rectangular duct 12 in x 12 in [300 mm x 300 mm], 1.0 in [25 mm] fiberglass D1.3.2 (see Note 2).	-2	-6	-16	-40	-40	-5
	 Rectangular Tee attenuation entering branch duct (D1.4.4)	0	0	-1	-5	-7	-5
	 Branch Power Division, 50% split, D1.1	-3	-3	-3	-3	-3	-3
	 5.0 ft [1.5 m] unlined rectangular duct (D1.3)	0	0	0	0	0	0
	 3.0 ft [0.9 m] lined 8 in [200 mm] diameter non-metallic flexible duct (D1.3.3)	-4	-7	-14	-15	-16	-8
	 Duct breakout, 8 in [200 mm] diameter non-metallic flexible duct (D1.2.2)	-8	-8	-8	-9	-10	-13
	 Ceiling/Space Effect, Table D14, Type 1 Ceiling.	-16	-18	-20	-26	-31	-36
	 Flexible duct breakout path L_p at receiver location	31	22	0	*	*	*
	Discharge Path						
	 Terminal discharge L_w (from mfr's data, Table 5)	66	65	62	62	62	60
	 Environmental Adjustment Factor (6.2)	-2	-1	0	0	0	0
	 10 ft [3 m] lined rectangular duct, 12 in x 12 in [300 mm x 300 mm], 1.0 in [25 mm] fiberglass (D1.3.2) (see Note 2)	-2	-6	-16	-40	-40	-5
	 Rectangular Tee attenuation entering branch duct (D1.4.4)	0	0	-1	-5	-7	-5
	 Branch Power Division , 50% split (D1.1)	-3	-3	-3	-3	-3	-3

Table 8. Step-By-Step Calculation for the Procedural Example of Figure 6 (continued)							
SOUND PATH		Octave Band Mid Frequency, Hz					
PATH #	NAME	125	250	500	1000	2000	4000
	 5.0 ft [1.5 m] unlined rectangular duct (D1.3)	0	0	0	0	0	0
	 5.0 ft [1.5 m] lined, 8 in [200 mm] diameter non-metallic flexible duct (D1.3.3)	-5	-10	-18	-19	-21	-12
	 End reflection Factor, 8.0 in [200 mm] diameter (D1.5)	-10	-5	-2	-1	0	0
	 Space Effect (5.0 ft [1.5 m], 2400 cu ft [67 m ³] room, Table D15)	-5	-6	-7	-8	-9	-10
	 Discharge L _p at receiver location	39	34	15	*	*	25
6	Outlet #1 Generated						
	 Outlet generated L _w (from mfr's data, Table 5)	40	43	46	46	44	42
	 Environmental Adjustment Factor (6.2)	-2	-1	0	0	0	0
	 Space Effect (5.0 ft [1.5 m], 2400 cu ft [67 m ³] room, Table D15)	-5	-6	-7	-8	-9	-10
	 Outlet generated L _p at receiver location	33	36	39	38	35	32
* Less than zero dB							
Note 1: For lined duct lengths up to 15 ft [4.5 m], take ½ duct insertion loss before calculating breakout (max. 7.5 ft [2.3 m])							
Note 2: The maximum recommended lined duct attenuation in any octave band is 40 dB. See D1.3.2.							

The contributions of the six individual paths as shown on the acoustic model will be combined to obtain the total Sound Pressure Level, L_p at the receiver location. A similar calculation may be completed for various receiver locations (i.e., directly under the terminal or directly under the diffuser) in order to determine the acoustically critical receiver location.

The paths considered are:

1. Radiated and induction inlet
2. Duct Breakout
3. Distribution Duct Breakout
4. Flexible Duct Breakout
5. Discharge
6. Outlet #1 Generated

Table 9. Summary – Combination of Path Results Using Logarithmic Addition, dB							
Path #	Description	Octave Band Mid Frequency, Hz					
		125	250	500	1000	2000	4000
1	Radiated and induction inlet path	46	41	37	32	24	16
2	Duct breakout path	23	15	2	*	*	*
3	Distribution duct breakout path	19	10	0	*	*	*
4	Flexible duct breakout path	31	22	0	*	*	*
5	Discharge path	39	34	15	*	*	26
6	Outlet #1 generated path	33	36	39	38	35	32
Total L_p at receiver location check numbers here		47	43	41	39	35	33
* less than zero dB							
Note: In this example it can be seen that the critical paths are casing radiated (Path #1), discharge (Path #5) and outlet generated (Path #6).							

6.6 Additional Acoustic Models. Examples of the acoustic paths involved with single/dual duct terminal boxes and integral diffuser terminals are illustrated in Figures 7 and 8. The associated path factor calculations are tabulated in the summary calculation Tables 10 and 11 which list the source of the attenuation data.

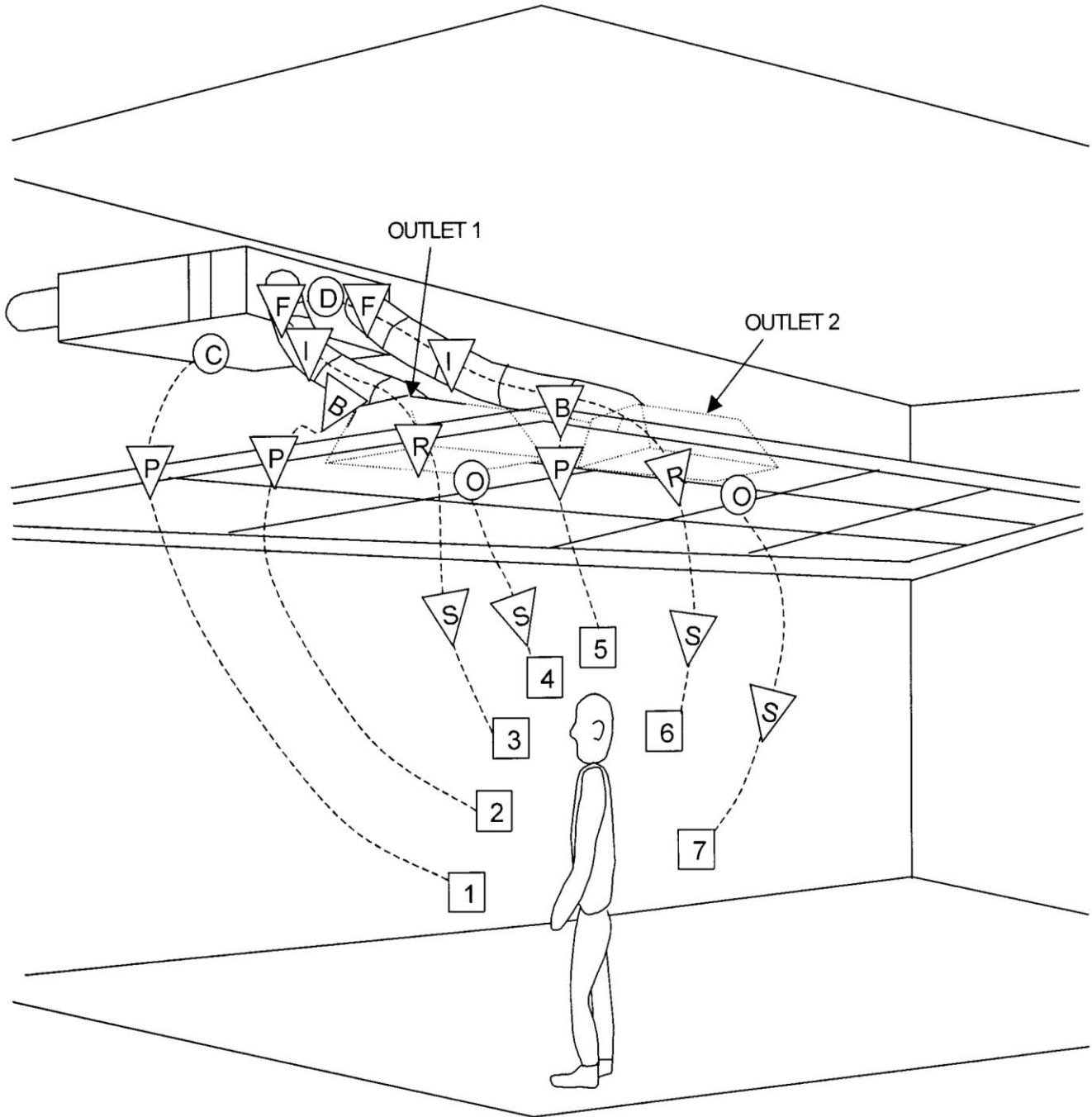

Figure 7. Single/Dual Duct Terminal – Summary Calculation Sound Sources and Paths

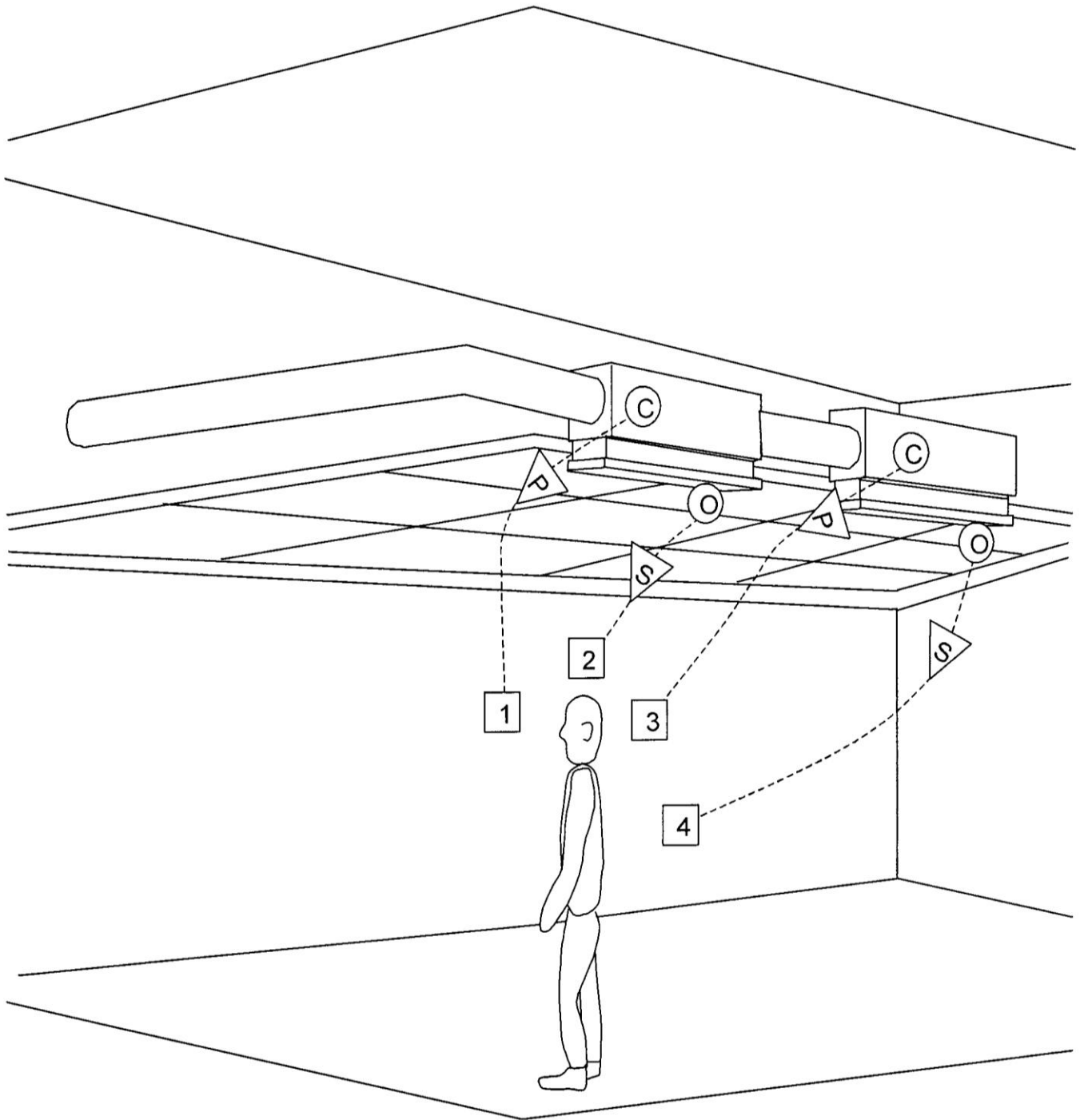

Figure 8. Integral Terminal – Summary Calculation Sound Sources and Paths

Table 10. Calculation – Single/Dual Duct Terminal (Ref: Figure 7)



























Source Path		Sound Source	Path Attenuation Calculation		
Path #	Name		Symbol	Name	Find Calculation Method In
1	Terminal Casing Radiation	(C)		Ceiling/Space Effect	D1.6
2	Flex Duct Breakout Radiation	(D)	   	Branch Power Division Duct Insertion Loss Duct Breakout Transmission Loss Ceiling/Space Effect	D1.1 D1.3 D1.2 D1.6
3	Duct Airborne Sound	(D)	   	Branch Power Division Duct Insertion Loss End Reflection Factor Space Effect	D1.1 D1.3 D1.5 D1.7
4	Outlet #1 Generated Sound	(O)		Space Effect	D1.7
5	Flex Duct Breakout Radiation	(D)	   	Branch Power Division Duct Insertion Loss Duct Breakout Transmission Loss Ceiling/Space Effect	D1.1 D1.3 D1.2 D1.6
6	Duct Airborne Sound	(D)	   	Branch Power Division Duct Insertion Loss End Reflection Factor Space Effect	D1.1 D1.3 D1.5 D1.7
7	Outlet #2 Generated Sound	(O)		Space Effect	D1.7

Table 11. Calculation – Integral Terminal (Ref: Figure 8. Acoustic Model)					
Source Path		Sound Source	Path Attenuation Calculation		
Path #	Name		Symbol	Name	Find Calculation Method In
1	Terminal Radiation			Ceiling/Space Effect	D1.6
2	Terminal Discharge & Outlet Generated Sound			Space Effect	D1.7
3	Terminal Radiation			Ceiling/Space Effect	D1.6
4	Terminal Discharge & Outlet Generated Sound			Space Effect	D1.7

Section 7. Use of Noise Criteria (NC) and Room Criteria (RC)

7.1 Acoustic Design Goals. A proper acoustical environment is as important for human comfort as other environmental factors controlled by air-conditioning systems. The objective of sound control is to achieve an appropriate sound level for all activities and people involved, not the lowest possible level. Because of the wide range of activities and privacy requirements, appropriate indoor acoustical design levels may vary considerably from space to space.

The designer’s fundamental concern is how humans respond to sound. Under carefully controlled experimental conditions, people can detect small changes in sound levels. However, the human reaction describing halving or doubling of perceived loudness of a sound requires changes in Sound Pressure Level of about 10 dB. In a typical environment for broadband sounds, 3 dB is a typical minimum perceptible change. This means that halving the power output of the source results in a barely noticeable change in Sound Pressure Level, and the power output must be reduced by 10 dB before people determine that loudness has been halved. Typical subjective changes are shown in Table 12.

7.1.1 Choosing Indoor Acoustical Design Goals. Several factors should be considered in choosing the appropriate indoor design goal for mechanical sound systems in buildings. The type of space-use served by the system dictates the maximum background sound level for acceptable environmental conditions. The “quality” of the background sound is a function of its spectrum shape, an important factor. If the sound is rumbly, hissy, or tonal, it may be objectionable even though its level is not excessive. A minimum level of background sound is desirable in many situations to maintain a degree of acoustical privacy in a multiple-occupancy environment. Examples are: (1) open-plan offices, where some masking of unwanted speech and other “activity-generated” noises are essential and (2) partitioned spaces whose construction provides only a marginal amount of sound transmission loss.

Table 12. Subjective Effect of Changes in Sound Pressure Level, Broadband Sounds

Change in Sound Pressure	Apparent Change in Loudness
3 dB	Just noticeable
5 dB	Clearly noticeable
10 dB	Twice (or half, as loud)

Reprinted with permission of the American Society of Heating, Refrigerating & Air-Conditioning Engineers. 2005 ASHRAE Handbook, Fundamentals, P7.15, Table 8

The sound produced by an air distribution system is frequently the principal factor governing the level of steady-state background sound within the conditioned space. Another factor to be considered is the transient intrusion of outdoor noises, such as those from traffic. The internally generated noises resulting from space activities or equipment may also contribute to the level of the background environment. When the level of outdoor noise is high (e.g., near a heavily traveled roadway), the level of transmission through the building envelope may not justify using the same design goal for system noise control as might be chosen with a quieter exterior environment or a higher transmission loss building envelope.

Therefore, it is important to recognize that the system noise control goal is a variable that depends closely on space-use requirements.

It is also important to recognize that the degree of occupancy satisfaction achieved with a given level of background sound is multidimensional. To be unobtrusive, it should have the following properties:

1. A balanced distribution of sound energy over a broad frequency range.
2. No audible tonal characteristics such as a whine, whistle, hum, or rumble.
3. No noticeable time-varying levels from beats or other system-induced aerodynamic instability.

In other words, the background sound should be steady in level, bland in character, and free of identifiable machinery noises.

7.1.2 NC Curves. The NC (Noise Criteria) curves (Figure 10 and Table 13) have been widely used for many years. In practice, these curves define the limits that the octave band spectrum of a noise source must not exceed to achieve a level of occupant acceptance. For example, an NC-35 design goal is commonly used for private offices; the background noise level meets this goal provided no portion of its spectrum lies above the designated NC-35 curve.

NC is a convenient tool, used industry wide, for providing a single number rating of terminal units and diffusers. If reasonable attenuation assumptions are employed, such as provided in this document, the use of NC can provide an excellent means of determining the suitability of these devices in a given application. Air Terminals typically cause the NC to be determined in the lower frequencies, with the result that the NC value is useful in room sound analysis only at the lower frequencies. Diffusers, on the other hand, typically peak in the mid frequencies, and NC values are typically in the speech interference regions. In most cases, NC values from diffusers and Terminals cannot, therefore, be considered to be additive.

There are two problems in using the NC design goal:

1. If the NC is determined by a singular tangent peak, the actual level of resulting background sound may be quieter than desired for masking unwanted speech and activity noises, because the spectrum on either side of the tangent peak drops off too rapidly.
2. If the shape of the NC-curve is matched approximately, the resulting sound can be either rumbly or hissy, depending on where the match occurs.

In other words, the shape of the NC-curve is not that of an optimal well balanced, bland-sounding noise. Therefore, NC-curves should be used with caution in critical noise situations where the background sound of the air-conditioning system is required to mask speech and activity noise.

7.1.3 RC Curves. The shape of these curves (Figure 11 and Table 14) differs from that of the NC curves at both low and high frequencies.

While RC ratings may be an excellent tool for evaluating all sound in a space, they are not practical as a means of rating Air Terminals.

The shape of the RC curve is a close approximation to a well balanced, bland-sounding spectrum. It provides guidance whenever the space requirements dictate that a certain level of background sound be maintained for masking or other purposes. Generally, it is desirable to approximate the shape of the curve within ± 2 dB over the entire frequency range to achieve an optimum balance in sound quality. If the low frequency levels (31.5 to 250 Hz) exceed the design curve by as much as 5 dB, the sound is likely to be rumbly; exceeding the design curve by 3 dB at

high frequencies (2000 to 4000 Hz) causes the sound to be hissy.

The RC procedure for noise rating corrects several of the shortcomings of the A-weighted sound level and NC rating methods, because the shape of the noise spectrum is taken into account in the assessment of sound quality. In addition, the frequency range of evaluation extends down to the 16 Hz Octave Band, thus addressing problems associated with excessive low-frequency noise.

The procedure for determining the RC rating of an octave band noise spectrum provides valuable information for use in estimating the likely acceptability of a given system design. Four steps are required in the procedure:

1. The first step is to plot the spectrum to be rated, and then calculate the arithmetic average of the octave band levels in the 500, 1000, and 2000 Hz Octave Bands. This average value becomes the numerical part of the RC rating which is important in addressing the speech communication or acoustical privacy requirements of the application, which are affected by the Sound Pressure Levels in this frequency region.
2. The second step is to plot a reference curve that has a slope of -5 dB/octave from 16 Hz to 4000 Hz, which passes through the 1000 Hz Octave Band at the average value determined in the first step. This reference curve represents the optimum shape of a “neutral-sounding” spectrum having the same degree of speech communication or acoustical privacy as the spectrum being rated.
3. The third step is to plot the limits above the reference curve which cannot be exceeded by the noise spectrum being rated, in order to be classified as a neutral-sounding, subjectively inoffensive sound. The limits are +5 dB, for the 16 Hz through 500 Hz Octave Bands, and +3 dB, for the 1000 Hz through 4000 Hz Octave Bands.
4. The final step is to note any deviations in the noise spectrum that exceed the level of the reference curve. If the deviations do not exceed 5 dB in the Octave Bands from 16 Hz to 500 Hz, nor 3 dB in the Octave Bands from 1000 Hz to 4000 Hz, the spectrum is classified as “neutral,” and the letter descriptor, (N), is appended to the numerical RC rating obtained in step one. However, if the deviations exceed 5 dB in the lower frequency range, the spectrum is classified as “rumbly” and assigned the letter descriptor “R.” Conversely, if the deviations are in excess of 3 dB in the upper frequency range, the spectrum is classified as “hissy” and assigned the letter descriptor “H.”

An example using the RC (N) rating procedure is illustrated in Figure 9. The spectrum to be rated is shown as the coded heavy solid line. The average of the Sound Pressure Levels in the 500, 1000, and 2000 Hz Octave Bands is 35 dB, and this establishes the level of the -5 dB/octave reference curve in the 1000 Hz Octave Band (heavy dashed curve). The permissible low-frequency limit above the reference curve of +5 dB (from 16 through 500 Hz) is plotted as the lighter dashed line; the permissible high-frequency limit above the reference curve (1000 through 4000 Hz) of +3 dB is plotted as the dotted line. This spectrum has a rating of RC 35(R), because the levels at 16, 31.5 and 63 Hz exceed the low-frequency limit curve.

With regard to achieving occupant satisfaction, it is obviously desirable to obtain an “N” rating in the assessment of sound quality. Should the spectrum receive an “R” or “H” rating, a potential for occupancy complaints exists. As a general rule, rumble and hiss complaints are likely if the levels of the spectrum exceed the reference curve by more than 5 dB or 3 dB, respectively.

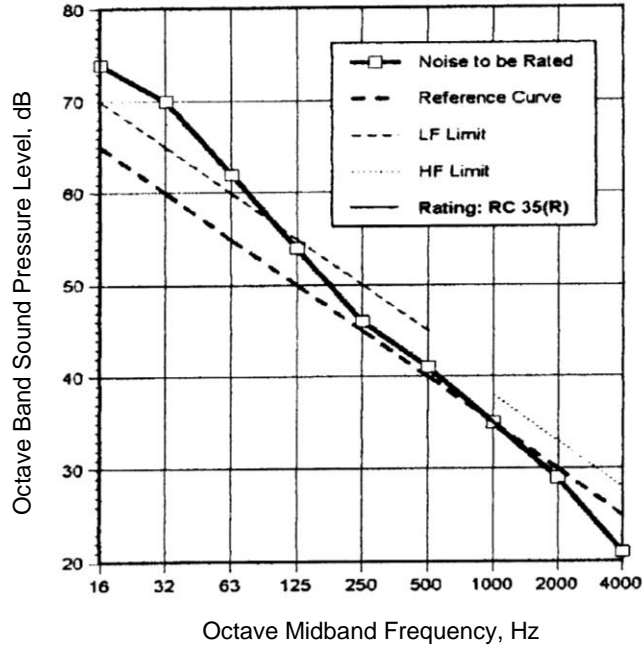

Figure 9. Example of Steps to Assign an RC Rating to a Noise Spectrum

The spectrum shown in Figure 9 has a rating of RC 35(R). It has a rumbly character, because the low-frequency limit curve is exceeded in the 16, 31.5 and 63 Hz Octave Bands.

When a terminal is rated against RC requirements, a low numerical value, with an ‘R’ rating usually results. The numerical value that results (the average of the 500, 1000 and 2000 frequency bands) is typically so low that it has no impact on sound quality in the space, and the resultant ‘R’ rating, gives no discrimination between units. RC is not therefore recommended, or practical, as a means of single number rating an Air Terminal. For diffusers, they usually result in a value identical to the determined NC value.

Recommended RC design levels are given in Table 15.

The ranges of Table 15 are based on the fact that sound radiated from properly designed and maintained air-conditioning equipment is typically steady and broadband in character.

7.1.4 Recommended Practice to Specify Device Sound Levels. For the purpose of specifying sound levels for air distribution products, there are two basic methods which will result in predictable sound levels in an office space.

7.1.4.1. Maximum Allowed NC. If application assumptions included in this document are utilized in determining a product’s NC value, if the assumptions are clearly outlined, and if the sound power data is representative of the product performance at design conditions, then a maximum allowable NC can provide a good means of assuring resultant room Sound Pressure Levels for Air Terminals. Required diffuser NC values may be adjusted for differences between the 10 dB attenuation assumed in the product ratings and the known room requirements. The specifying engineer should clearly state the assumptions to be used in determining the product’s NC value.

7.1.4.2 Maximum Allowed Sound Power. By starting with a desired room Sound Pressure Level, which could be an RC (N) value selected from Table 16 translated to octave band sound levels, the design engineer can determine the maximum allowed product octave band mid frequency values by adding the attenuation elements to the desired result. This process will essentially be the reverse of Table 8, for the critical discharge and radiated paths, as shown in Table 16.

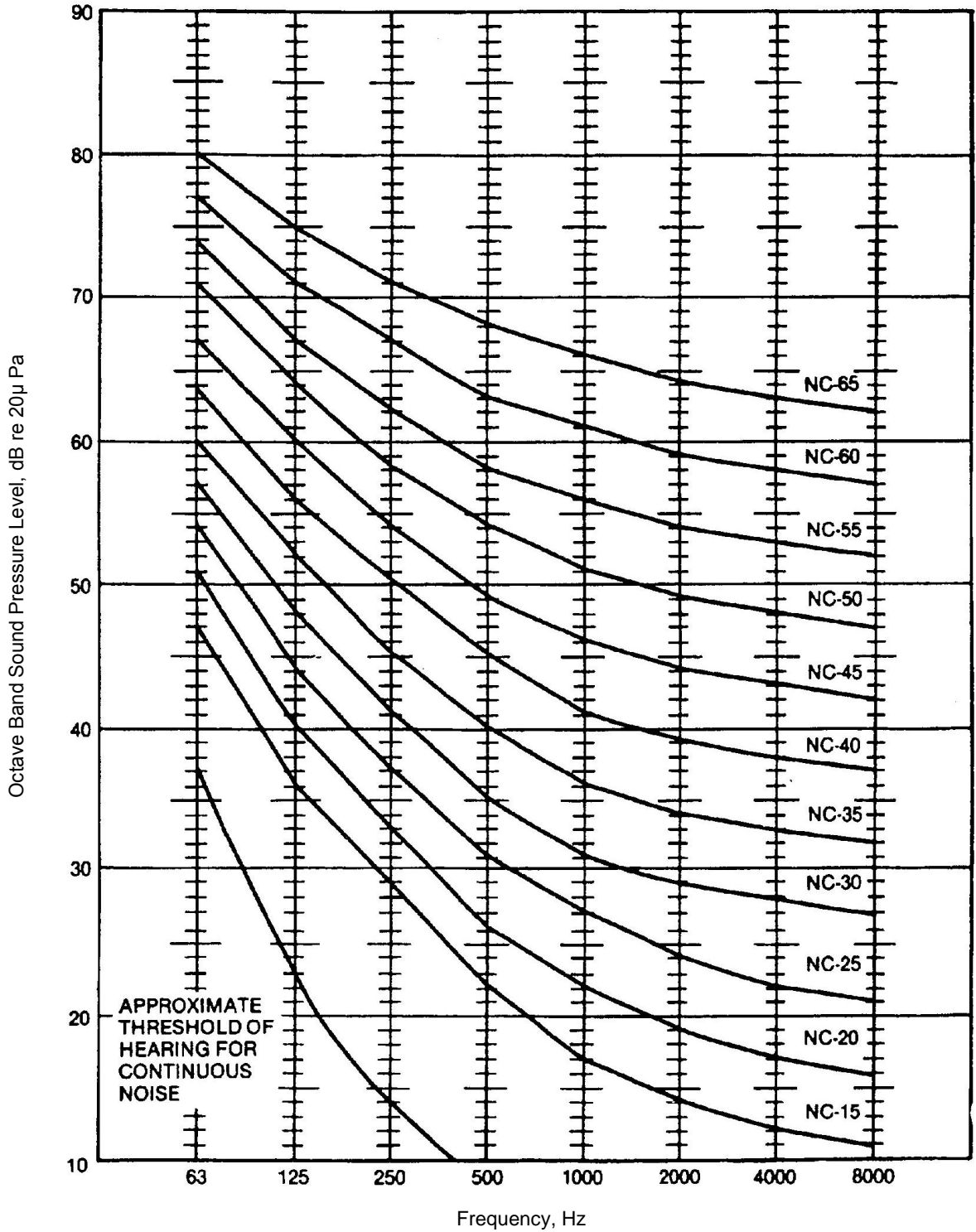

Figure 10. NC Curves for Specifying the Design Level in Terms of the Maximum Permissible Sound Pressure Level for Each Frequency Band

Reprinted with permission of the American Society of Heating, Refrigerating & Air Conditioning Engineers, 2005 ASHRAE Handbook, Fundamentals, Chapter 7 page 7.16, Figure 7.

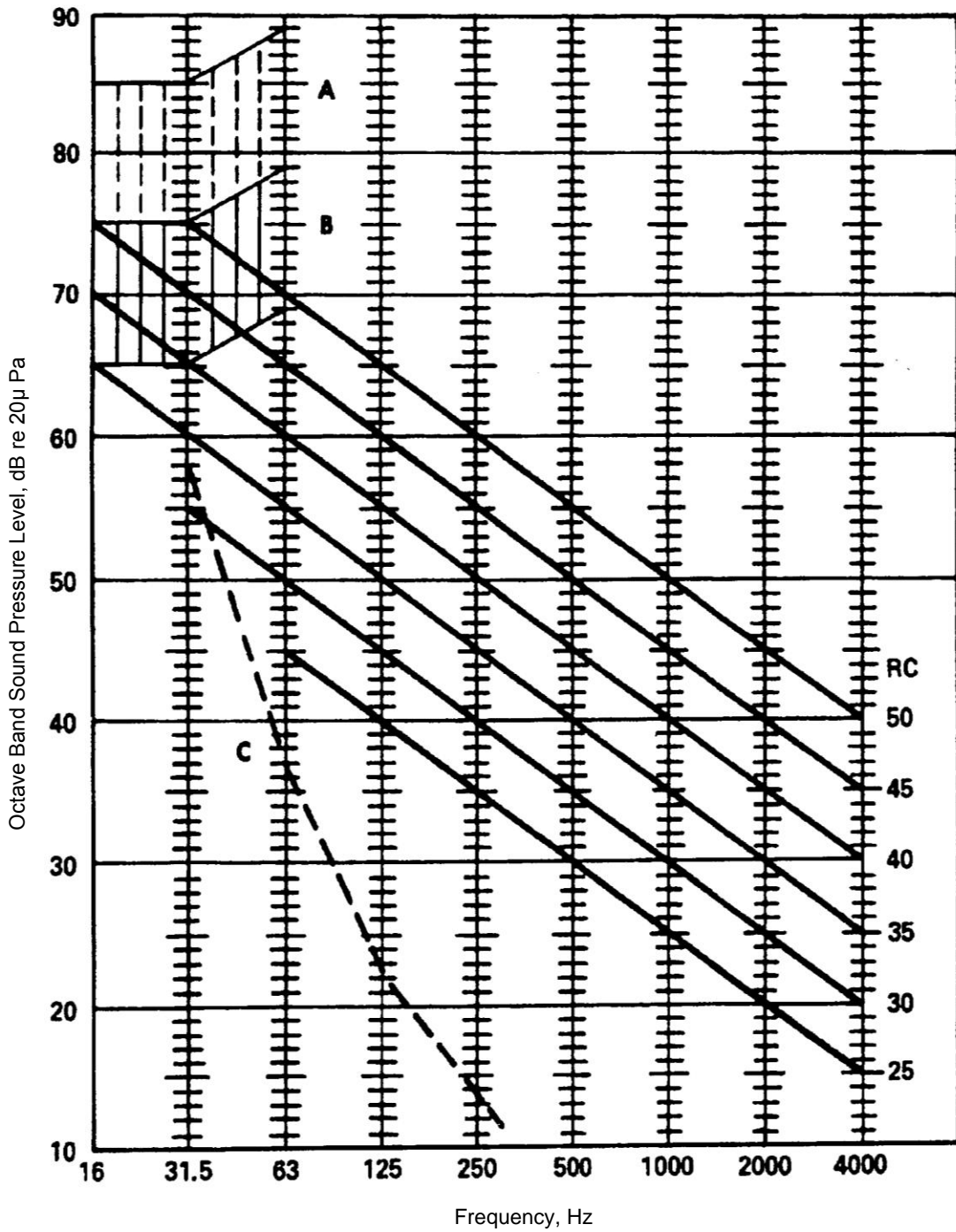

Figure 11. RC Curves for Specifying the Design Level in Terms of a Balanced Spectrum Shape

Reprinted with permission of the American Society of Heating, Refrigerating & Air Conditioning Engineers, 2005 ASHRAE Handbook, Fundamentals, Chapter 7 page 7.17, Figure 9.

Table 13. Tabular Representation of NC Curves, dB								
NC	Octave Band							
	63	125	250	500	1000	2000	4000	8000
15	47	36	29	22	17	14	12	11
20	51	40	33	26	22	19	17	16
25	54	44	37	31	27	24	22	21
30	57	48	41	35	31	29	28	27
35	60	52	45	40	36	34	33	32
40	64	56	50	45	41	39	38	37
45	67	60	54	49	46	44	43	42
50	71	64	58	54	51	49	48	47
55	74	67	62	58	56	54	53	52
60	77	71	67	63	61	59	58	57
65	80	75	71	68	66	64	63	62

Table 14. Tabular Representation of RC Curves, dB									
RC	Octave Band								
	16	31.5	63	125	250	500	1000	2000	4000
25	--	--	45	40	35	30	25	20	15
30	--	55	50	45	40	35	30	25	20
35	65	60	55	50	45	40	35	30	25
40	70	65	60	55	50	45	40	35	30
45	75	70	65	60	55	50	45	40	35
50	80	75	70	65	60	55	50	45	40

Section 8. Other Design Considerations to Meet Acoustic Goals

8.1 Designers can use the material presented in this Standard to:

1. Establish appropriate acoustic space sound level goals and
2. Establish Sound Power (L_w) requirements for Air Terminals and air outlets. Section 8 addresses design considerations beyond source sound power requirements which can help in achieving the desired space sound level goals.

In mechanical systems using variable air volume, it may not be possible to fill in the higher frequencies when the quantity of air supplied is moderate to low. If acoustic privacy is important, it may be necessary to provide controlled amounts of electronic masking noise or to advise the building designer to take alternative steps.

Table 15. Design Guidelines for HVAC System Noise in Unoccupied Spaces	
Space	RC (N)
Residences, Apartments, Condominiums	25 to 35
Hotels/motels	
Individual rooms or suites	25 to 35
Meeting/banquet rooms	25 to 35
Corridors, lobbies	35 to 45
Service/support areas	35 to 45
Office Buildings	
Executive and private offices	25 to 35
Conference rooms	25 to 35
Teleconference rooms	≤ 25
Open plan offices	≤ 40
With sound masking	≤ 35
Corridors and lobbies	40 to 45
Hospitals and clinics	
Private rooms	25 to 35
Wards	30 to 40
Operating rooms	25 to 35
Corridors and public areas	30 to 40
Performing Arts Spaces	
Drama theaters	25
Concert and recital halls	25
Music teaching studios	25
Music practice rooms	30 to 35
Laboratories (with fume hoods)	
Testing/research, minimal speech communication	45 to 55
Research, extensive telephone use, speech communication	40 to 50
Group teaching	35 to 45
Churches, mosques, synagogues	
With critical music programs	25 to 35
Schools ¹	
Classrooms	25 to 30
Large Lecture rooms	25 to 30
Without speech amplification	≤ 25
Libraries	30 to 40
Courtrooms	
Unamplified speech	25 to 35
Amplified speech	30 to 40
Indoor stadiums and gymnasiums	
School and college gymnasiums and natatoriums	40 to 50
Large seating capacity spaces (with amplified speech)	45 to 55

¹ Some educators and others believe that HVAC-related sound criteria for schools, as listed in previous editions of this table, are too high and impede learning for affected groups of all ages. See ANSI Standard S12.60-2002 (Reaffirmed 2007) for classroom acoustics and a justification for lower sound criteria in schools. The HVAC component of total noise meets the background noise requirement of that standard if HVAC-related background sound ≤ RC 25(N).

Reprinted with permission of the American Society of Heating, Refrigerating and Air-Conditioning Engineers, 2007 ASHRAE Handbook, HVAC Applications, Chapter 47, Table 42.

8.2 *Accurate Sound Power Data.* Select products with AHRI certified sound power data. Certified data assures more accuracy in the calculations in this Standard.

8.3 *Location of Air Terminals Relative to Noise Sensitive Areas.* It is often possible to physically locate Air Terminals to minimize their impact on noise sensitive areas. In doing so, consider both radiated and discharge sound.

To minimize the radiated sound contribution, locate Air Terminals above non-critical areas like corridors, copy machine areas and file areas. Quite often, sensitive executive offices are located at the building perimeter. Mounting Air Terminals over these areas should be avoided.

To minimize the discharge sound contribution, consider using a larger number of smaller diffusers. Locate Air Terminals to allow a large degree of attenuation in the downstream airborne path, (i.e., longer runs of insulated duct).

8.4 *Location of Air Terminals in Ceiling Plenum.* Where possible, locate Air Terminals in the largest possible ceiling plenum volume. Larger plenums generally increase ceiling space effect. Good practice dictates that at least 2.0 in [51 mm] clearance be established between the ceiling tile and the bottom of the unit.

8.5 *Location of Return Air Openings.* Return air openings provide a direct sound path through the ceiling. Avoid locating unducted returns directly below system elements with large radiated sound contributions, especially Air Terminals and adjacent flex duct.







8.6 *Design Inlet Static Pressure.* Sound generated by Air Terminal dampers increases as a function of both airflow and inlet static pressure. Try to design duct systems which provide adequate but not excessive static pressure at the Air Terminal primary air inlet.

8.7 *Duct at Terminal Inlet and Outlet.* Ductwork to and from the Air Terminal can radiate sound. The amount of sound breakout depends on the length of duct, sound level inside the duct and the attenuating properties of the duct itself.

Non-metallic flexible duct and fiberglass ductboard allow significantly greater breakout sound levels than metal duct. In addition, flex duct can generate sound if bends, sagging or compression takes place, increasing the internally generated sound level. Accordingly, try to minimize the use of flex duct at the Air Terminal unit inlet and use fiberglass lined metal duct at the outlet.

8.8 *Generated Flow Noise in Duct Fittings and Elbows.* This standard does not cover the calculation of generated sound from these fittings. Generated sound occurs due to abrupt transitions, sharp edges, adjacent fittings and high velocities. Avoiding these circumstances by design can prevent excessive generated sound. Refer to the latest ASHRAE Handbook, *HVAC Applications*, Chapter 47, for fitting suggestions.

8.9 *More Design Recommendations in the ASHRAE Handbook.* The 2007 ASHRAE Handbook, *HVAC Applications*, Chapter 47, contains further recommended actions, especially for proper airflow conditions to an air outlet.

Table 16. Example: Determination of Maximum Allowable Sound Power, dB							
Radiated Sound		Octave Band Mid Frequency, Hz					
Path	Description	125	250	500	1000	2000	4000
Required L_p , at Receiver Location, RC 40 (N)		60	55	45	40	38	33
	Environmental Adjustment Factor (see 6.2)	-2	-1	0	0	0	0
	Ceiling/Space Effect (Mineral Tile, Table D14, Type 1 Ceiling)	-16	-18	-20	-26	-31	-36
Maximum Allowed Product L_w , Radiated		78	74	65	66	69	69
Discharge Sound							
Required L_p , at Receiver Location RC 40 (N)		60	55	45	40	38	33
	Environmental Adjustment Factor (see 6.2)	-2	-1	0	0	0	0
	10 ft [3 m] Lined Rectangular Duct, 12 in x 12 in [300 x 300 mm] 1.0 in [25 mm] Fiberglass D1.3.2	-2	-6	-16	-40	-40	-5
	Branch Power Division 50% split, D1.1	-3	-3	-3	-3	-3	-3
	End Reflection Factor, 8 in [200 mm] diameter	-10	-5	-2	-1	0	0
	Space Effect (5.0 ft [1.5 m], 2400 cu ft [67 m ³] room, Table D16)	-5	-6	-7	-8	-9	-10
Maximum Allowed Product L_w , Discharge		82	76	73	92	90	51

Section 9. Field Sound Diagnostics and Troubleshooting

9.1 This standard details how to predict the resultant sound levels in a space. When the space is occupied, the design may need to be verified and corrective actions taken if problems are discovered.

When conducting an evaluation in a finished space, a number of parameters must be evaluated in order to determine the causes for the resultant sound levels. These factors include the actual finished structure components, the actual operating conditions and sound sources not considered in the original analysis.

9.2 *Suggested Procedures for Field Verification of NC/RC (N) Levels.* A number of observations must be made in order to verify the acoustical model. Primary of these is to assure that the input parameters utilized in the model are in fact valid. These include:

9.2.1 Construction Details

- a. Branch and supply duct construction (flex, rigid, etc.)
- b. Location and settings of balancing dampers
- c. Ceiling/space materials (confirming space use is as designed)

9.2.2 Unit Installation. Verify that the installed unit models are as specified and/or submitted and that they are the size specified.

9.2.3 Verify Actual Operating Conditions. Operating conditions, including actual terminal and outlet airflow, inlet pressures and proper unit operation must be measured and/or verified. If design conditions are to be evaluated, some temporary modification of the control system may be required.

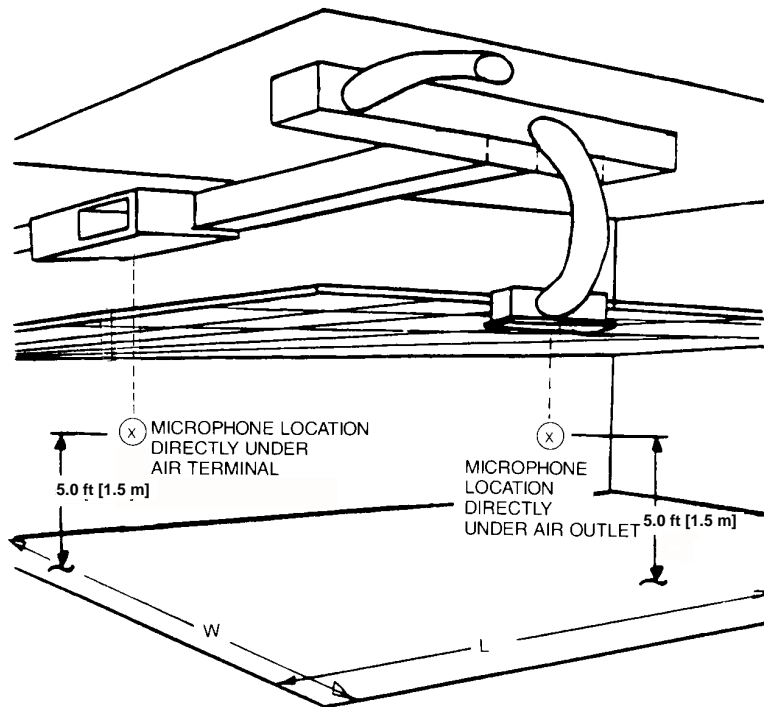

Figure 12. Suggested Prediction Locations in Small Rooms

9.2.4 Background Sound Levels. Among these are electronic background masking sound sources, supply air noise from the building’s primary system and breakout noise from the equipment room (typically through return air ductwork). If background noise is too high, or cannot be eliminated, HVAC system noise cannot be evaluated.

9.2.5 Measurement of Room Sound Pressure. Room Sound Pressure Levels are measured with sound pressure level meters. The microphone locations are critical to the resultant analysis. Figure 12 shows the recommended measurement locations. Minimum distance to a wall should be 3 ft [0.9 m].

9.2.5.1 Suggested Microphone Locations in Small Rooms. The measurement location for field verification of noise levels in a small room where L and W are less than 30 ft [9 m] should be taken at positions 5.0 ft [1.5 m] above the floor directly under the center of the air terminal device(s) and directly under the air outlet(s) (Figure 12). If low frequency standing waves are detected in the room, it is recommended that data also be taken at the four locations shown in Figure 13 and averaged logarithmically per Equation 9.1 to determine a representative octave band level in the space for each Octave Band.

9.2.5.2 Suggested Microphone Location in Large and/or Open Plan Rooms With Modular Outlet Locations. The measurement locations for field verification of sound levels in large or open plan rooms where L and/or W are greater than 30 ft [9 m] should be taken at a position 5.0 ft [1.5 m] above the floor directly under the center of four diffusers in a typical array and also under the terminal device(s). Average the data by using logarithmic addition per equation shown in the following equation.

$$L_p = 10 \log \left[10 \left(\frac{L_{p1}}{10} \right) + 10 \left(\frac{L_{p2}}{10} \right) + \dots + 10 \left(\frac{L_{pn}}{10} \right) \right] - 10 \log N$$

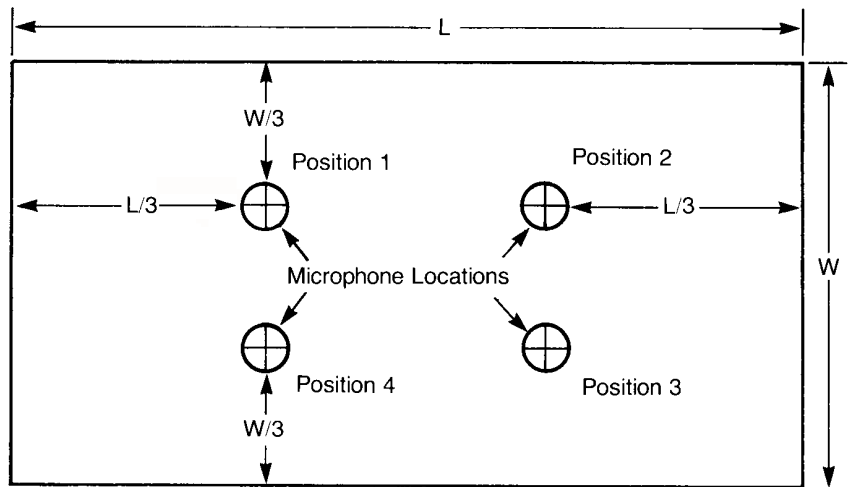

Figure 13. Suggested Small Room Microphone Locations if Low Frequency Standing Waves are Present

9.3 Troubleshooting (Diagnosis). If there is significant difference between the predicted and observed data, e.g., greater than 5 RC or NC points, a number of diagnostic procedures can be implemented. These include the obvious solutions of correcting deviations to the construction design, or, operating conditions of the units involved, or they may require additional measurements. These include the following.

9.3.1 Narrow-Band Analysis. Using a narrow band frequency analyzer, pure tones, such as from electric motors, may be broken out from the octave or one third octave band data, and identified.

9.3.2 Component Sound Power Measurements. The Sound Power of individual elements in the system may need to be determined. Typical methods for source identification are subjective evaluation, sequential lagging, or removal of acoustical components. Individual components may be removed and sent to sound analysis laboratories for analysis of sound performance. Two methods of sound measurements may be performed on site.

9.3.2.1 Close in sound measurements, using sound pressure microphones. This does not require different equipment than required for the room pressure level determination.

9.3.2.2 Acoustic intensity techniques may be employed in-place to determine Sound Power Levels provided by system components.

9.3.3 Typical Problems and Possible Solutions. Some typical noise problems and possible solutions are associated with:

- a. *Actual operating conditions not as designed.* Confirm the system is operating at or near the air flow and pressure drops used in the estimation process. This is often a large source of error. Verify static pressure control and controls that regulate flow are functioning properly. Make installation adjustments as needed.

- b. *Fan noise in a fan-powered mixing terminal.* Reduce the fan speed if possible or reselect the terminals for critical areas.
- c. *Valve noise.* Reduce the inlet pressure, if possible. Otherwise, replace the terminal with a lower pressure drop terminal and then reduce the inlet pressure.
- d. *Flexible duct breakout.* Replace with metal duct or lag the flex duct.
- e. *Diffuser noise.*
 - 1. Check the diffuser inlet to make sure that the damper is not almost fully closed and that there is an acceptable duct connection (flexible duct not crimped, etc.).
 - 2. Verify whether the diffuser noise is self-generated. An easy check is to remove the diffuser core. If the diffuser sound is self-generated, consider adding additional diffusers to achieve a lower airflow per diffuser or reselect the diffuser.
 - 3. If the noise is duct noise and is not generated by the diffuser, add internally lined duct attenuation upstream of the diffuser. Exterior lining provides little acoustical benefit.
- f. *Leakage.* Air leakage may result in airflows different than design resulting in higher than expected sound levels and pressures. Check and seal leaks.
- g. *Other.* If the air distribution system noise source cannot be significantly reduced or relocated, then it is necessary to use path attenuation to achieve desired acoustic goals. For Air Terminals or other sources above the ceiling tile (not diffusers), the following path attenuation modifications may be considered:
 - 1. Increase the absorption of the plenum cavity in the immediate area near the VAV Terminal.
 - 2. Relocate return air ducts, grilles, etc.
 - 3. Select a higher insertion loss ceiling tile system.
 - 4. Use an absorptive ceiling barrier under the noise source to provide some absorption and prevent direct radiation of terminal noise to the ceiling tile.
 - 5. Straighten flexible duct sections and eliminate unnecessary bends and sagging.

9.3.4 When the air distribution system acoustics is analyzed on paper before actual installation, there is much more flexibility in applying the appropriate noise reduction recommendations. Critical noise sources and attenuation paths can be identified and ranked. The source paths can be modified in order for the most effective solution until the acoustical requirements are met.

Section 10. Conformance Conditions

10.1 *Conformance.* While conformance with this Standard is voluntary, conformance shall not be claimed or implied for products or equipment within the standard's *Purpose* (Section 1) and *Scope* (Section 2) unless such product claims meet all of the requirements of the standard and all of the testing and rating requirements are measured and reported in complete compliance with the standard. Any product that has not met all the requirements of the standard shall not reference, state, or acknowledge the standard in any written, oral, or electronic communication.

APPENDIX A. REFERENCES – NORMATIVE

A1 Listed here are all standards, handbooks, and other publications essential to the formation and implementation of the standard. All references in this appendix are considered as part of the standard.

A1.1 AHRI Standard 880-2008 (formerly ARI Standard 880-2008), *Performance Rating of Air Terminals, Air-Conditioning, Heating, and Refrigeration Institute*, 2008, 2111 Wilson Blvd., Suite 500, Arlington, VA 22201, U.S.A.

A1.2 ANSI Standard S12.60-2002 (Reaffirmed 2007), *American National Standard Acoustical Performance Criteria, Design Requirements, and Guidelines for Schools*, 2007, American National Standards Institute, 25 West 43rd Street, 4th Fl., New York, NY 10036, U.S.A.

A1.3 ASHRAE *Handbook, Fundamentals*, 2005, American Society of Heating, Refrigerating, and Air-Conditioning Engineers, Inc., 1791 Tullie Circle, N.E., Atlanta, GA, 30329, U.S.A.

A1.4 ASHRAE *Handbook, HVAC Applications*, 2007, American Society of Heating, Refrigerating, and Air-Conditioning Engineers, Inc., 1791 Tullie Circle, N.E., Atlanta, GA, 30329, U.S.A.

A1.5 ASHRAE Research Report, RP-755, *Sound Transmissions Through Ceilings*, January 1997, American Society of Heating, Refrigerating, and Air-Conditioning Engineers, Inc., 1791 Tullie Circle, N.E., Atlanta, GA, 30329, U.S.A.

A1.6 ASHRAE Research Report, RP-1314, *Reflection of Airborne Noise at Duct Terminations*, 2008, American Society of Heating, Refrigerating, and Air-Conditioning Engineers, Inc., 1791 Tullie Circle, N.E., Atlanta, GA, 30329, U.S.A.

A1.7 ASHRAE Standard 70-2006, *Method of Testing for Rating the Performance of Air Outlets and Inlets*, 2006, American Society of Heating, Refrigerating, and Air-Conditioning Engineers, Inc., 1791 Tullie Circle, N.E., Atlanta, GA, 30329, U.S.A.

A1.8 ASHRAE Standard 130-2007, *Methods of Testing for Rating Ducted Air Terminal Units*, 2007, American Society of Heating, Refrigerating, and Air-Conditioning Engineers, Inc., 1791 Tullie Circle, N.E., Atlanta, GA, 30329, U.S.A.

A1.9 ASHRAE *Terminology of Heating, Ventilation, Air Conditioning, & Refrigeration*, 1991, American Society of Heating, Refrigerating, and Air-Conditioning Engineers, Inc., 1791 Tullie Circle, N.E., Atlanta, GA, 30329, U.S.A.

APPENDIX B. REFERENCES – INFORMATIVE

None.

APPENDIX C. ENVIRONMENTAL ADJUSTMENT FACTOR – NORMATIVE

C1 *Purpose.* To document the technical basis for the values used in Section 5.1 for the Environmental Adjustment Factor

◊_E.

This factor becomes necessary because at low frequencies, all real occupied spaces behave acoustically more like Reverberation Rooms than open spaces (free field).

At the present time, industry sound power databases for Air Terminal and outlet diffusers are based on the use of free field calibration of the reference sound sources.

C.1.1 ◊_E *Environmental Adjustment Factor.* An issue that must be dealt with when predicting Sound Pressure Levels in a room is the “Environmental Adjustment Factor.” The Sound Power measured for a Source placed on the floor of a hemi-anechoic space is generally found to be less than the Sound Power for the same Source placed on the floor of a Reverberation Room. This difference is attributed to the different impedance presented to the Source by the Reverberation Room. A great deal of work has been done to study the causes of the difference between the two methods. For this report, it is only the magnitude of the difference that is immediately relevant for making predictions of Sound Pressure Levels in rooms for the following reasons.

$$\diamond E = L_{WFF} - L_{WRF}$$

Where:

L_{WFF} = Free Field Reference Sound Source Calibration Sound Power Level, dB re 10^{-12} Watt
 L_{WRF} = Reverberant Reference Sound Source Calibration Sound Power Level, dB re 10^{-12} Watt

Table C1. Environmental Adjustment Factor								
Octave Band Mid Frequency, Hz	63	125	250	500	1000	2000	4000	8000
Environmental Adjustment Factor, dB	4	2	1	0	0	0	0	0

These factors for ◊_E shall be subtracted from sound power data taken under a free field reference sound source (RSS) calibration to convert them to a reverberant RSS calibration base.

When Air Terminals are tested according to ASHRAE Standards 70 and 130, a reference sound source is used to generate Sound Pressure Levels in the Reverberation Room. The differences between these levels and those generated by the device under test are added to the power levels of the reference source to get the power of the device under test. This is the substitution technique. Adherence to this procedure means that the power levels found by following AHRI Standard 880 is equivalent to free-field power levels, assuming that both sources are affected by the room in the same way.

When devices are installed in real rooms, it is expected that the power level emitted at low frequencies will also be reduced because of the influence of the room. The question to be answered is, “How much should the power levels be reduced?”

Table C1 shows the Environmental Adjustment Factor recommended by ASHRAE research¹.

APPENDIX D. SOUND PATH FACTORS – NORMATIVE







D.1 The following specific calculation subsections detail the procedures and references necessary to obtain attenuation path results (see Table D1.).

D1.1 *Branch Power Division* . This calculation should be performed for each junction where a division of flow exists. At branch takeoffs, acoustic energy is distributed between the branches and/or the main duct in accordance with the ratio (B/T) of the branch cross-sectional areas (B) to the total cross sectional area of all ducts leaving the takeoff (T). Thus branch power division can be expressed by:

$$\text{Inverted Triangle with F} = \text{Branch Power Division (dB)} = 10 \log (B/T)$$

Table D2. is a tabular compilation of this power division to various ratios of B/T. For example, for Branch 2 in the illustration shown in Figure D1.:

$$\begin{aligned} \text{Branch Power Division (dB)} &= 10 \log (B/T) \\ &= 10 \log (A_2/(A_2 + A_3)) \end{aligned}$$

Table D1. Calculations for Attenuation Path Results			
PAGE NO.	REFERENCE #	SYMBOL	CALCULATION INSTRUCTION
39	D1.1		Branch Power Division
40	D1.2		Duct Breakout Transmission Loss, Lined or Unlined D1.2.1 Circular Sheet Metal D1.2.2 Flexible Duct, Lined & Unlined D1.2.3 Flat Oval Sheet Metal Duct, Lined or Unlined D1.2.4 Rectangular Sheet Metal Duct, Lined or Unlined
44	D1.3		Duct Insertion Loss D1.3.1 Lined Circular Sheet Metal D1.3.2 Lined Rectangular or Square Sheet Metal Duct D1.3.3 Flexible Duct D1.3.3.1 Unlined D1.3.3.2 Lined
49	D1.4		Round and Rectangular Duct Elbow and Tee Loss D1.4.1 Round Lined D1.4.2 Round Unlined D1.4.3 Rectangular Square Elbows D1.4.4 Rectangular Tee Loss
51	D1.5		End Reflection Factor
51	D1.6		Ceiling/Space Effect
53	D1.7		Space Effect

¹ ASHRAE Research Project RP755, *Sound Transmission through Ceilings from Air Terminal Devices in the Plenum*, Alf Warnock, NRC, Canada, January 1997.

55	D1.8	S_2	Distributed Array
55	D1.10	M	Manufacturer's Attenuation Elements

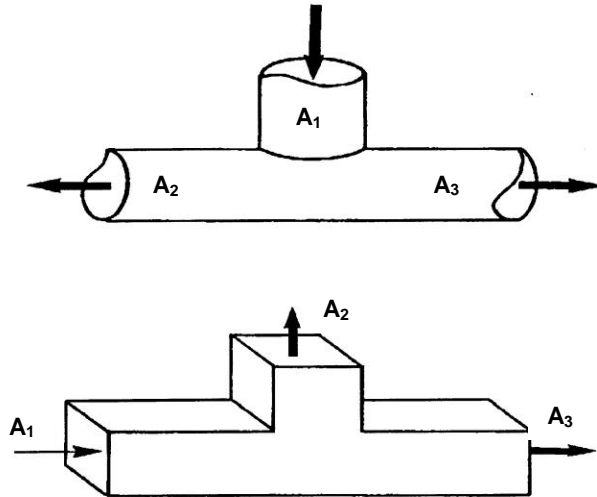

Figure D1. Branch Power Division

B/T	Division, dB	B/T	Division, dB
1.00	0	0.100	10
0.80	1	0.080	11
0.63	2	0.063	12
0.50	3	0.050	13
0.40	4	0.040	14
0.32	5	0.032	15
0.25	6	0.025	16
0.20	7	0.020	17
0.16	8	0.016	18
0.12	9	0.012	19

Reprinted with permission of the American Society of Heating, Refrigerating & Air Conditioning Engineers, 2007 ASHRAE Handbook, HVAC Applications, Chapter 47, Table 22.

D1.2 *Duct Breakout Transmission Loss, Lined or Unlined* B . Airborne acoustic energy within a duct can be transmitted through the duct walls. This transmission path is termed Duct Breakout.

The amount of acoustic energy transmitted is independent of external or internal duct insulation; the transmission is dependent on the duct geometry.

D1.2.1 *Circular Sheet Metal Duct*. B is calculated from the transmission loss characteristics of the duct and from the cross sectional & surface areas of the duct (see Figure D2.).

$$\nabla B = TL_{out} - 10 \log (A_r/A_i) = L_{wi} - L_{wo}$$

Where:

- A_r = πdL (Duct Surface Area), in² [mm²]
- A_i = $\pi \frac{d^2}{4}$ (Duct Cross Sectional Area), in² [mm²]
- d = Inside Diameter, in [mm]
- L = Length, in [mm]
- L_{wi} = Sound Power Level at Duct Inlet, dB
- L_{wo} = Sound Power Level Breaking Out of Ductwall, dB
- TL_{out} = Transmission loss, dB

Values for TL_{out} are given in Table D3.

NOTE: d & L must be expressed in the same units.

Calculation Procedure and Table D3 are reprinted with permission of the American Society of Heating, Refrigerating & Air Conditioning Engineers, 2007 ASHRAE Handbook, HVAC Applications, Chapter 47.

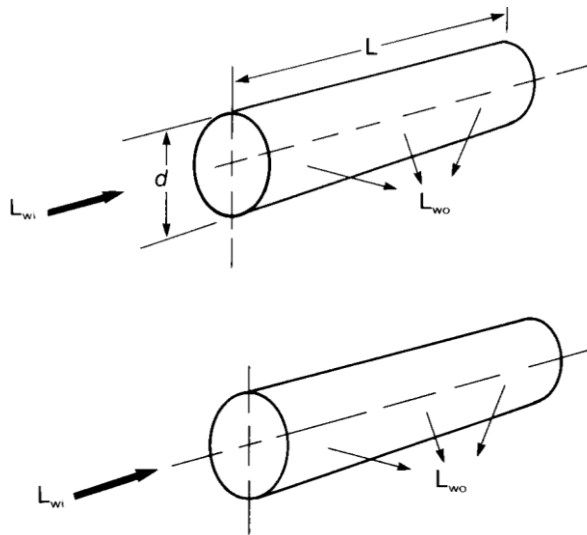

Figure D2. Circular Duct Breakout

D1.2.2 Flexible Duct, Lined & Unlined ∇B . Unlike circular sheet metal duct, radiated duct breakout for flexible duct (according to 2007 ASHRAE Handbook, HVAC Applications) is not directly proportional to length. Most breakout occurs in the first 1-2 ft [0.3 - 0.6 m] of the duct.

$$\nabla B = L_{wi} - L_{wo}$$

Values for TL_{out} for flexible duct are given in Table D4.

The values shown in Table D4 are for 10 ft [3 m] of length but can be used for any length up to 10 ft [3 m].

Table D3. TL_{out} versus Frequency for Various Circular Metal Ducts^a (Ref: D1.2.1), dB

Duct Diameter in [mm]	Duct Type in [mm]	Duct Length ft [m]	Octave Band Mid Frequency, Hz							
			63	125	250	500	1000	2000	4000	8000
8 in [200 mm]	0.022 in [0.55 mm] long seam	15 ft [4.5 m]	(45)	(53)	55	52	44	35	34	26
14 in [350 mm]	0.028 in [0.70 mm] long seam	15 ft [4.5 m]	(50)	60	54	36	34	31	25	38
22 in [550 mm]	0.034 in [0.85 mm] long seam	15 ft [4.5 m]	(47)	53	37	33	33	27	25	43
32 in [800 mm]	0.034 in [0.85 mm] long seam	15 ft [4.5 m]	(51)	46	26	26	24	22	38	43
8 in [200 mm]	0.022 in [0.55 mm] spiral wound	10 ft [3 m]	(48)	(64)	(75)	(72)	56	56	46	29
14 in [350 mm]	0.022 in [0.55 mm] spiral wound	10 ft [3 m]	(43)	(53)	55	33	34	35	25	40
26 in [650 mm]	0.028 in [0.70 mm] spiral wound	10 ft [3 m]	(45)	50	26	26	25	22	36	43
26 in [650 mm]	0.064 in [1.6 mm] spiral wound	10 ft [3 m]	(48)	(53)	36	32	32	28	41	36
32 in [800 mm]	0.034 in [0.85 mm] spiral wound	10 ft [3 m]	(43)	42	28	25	26	24	40	45
14 in [350 mm]	0.028 in [0.70 mm] long seam with two 90° elbows	15 ft [4.5 m] plus elbows	(50)	54	52	34	33	28	22	34

^a Parentheses indicate measurements in which background noise has produced a greater uncertainty than usual in the data. Parentheses are estimated values.

Table D4. Breakout Versus Frequency for 10 ft [3 m] Sections of Non-Metallic Flexible Duct, Lined and Unlined (Ref: D1.2.2), dB

Duct Diameter in [mm]	Octave Band Mid Frequency, Hz							
	63	125	250	500	1000	2000	4000	8000
4-6 [100-150]	9	9	9	9	10	12	15	21
7-8 [170-200]	8	8	8	8	9	10	13	18
9 [205]	7	7	7	8	8	10	12	17
10 [250]	7	7	7	7	8	9	11	16
12-16 [300-400]	5	5	5	5	6	7	9	13

Reference: Compilation of Manufacturers Data

dB = F · 0.00179 + 10.79 – D · (0.0000563 · F + 0.41419) Where: F = octave band mid-frequency in Hz, and D = diameter in inches.

D1.2.3 Flat Oval Sheet Metal Duct, Lined & Unlined  . Duct Breakout can be calculated from 2007 ASHRAE Handbook, HVAC Applications (see Figure D3.).

 = TL_{out} - 10 log (A_r/A_i) = L_{wi} - L_{wo}

Where:

- A_r = $L [2(a - b) + \pi b]$ = Duct Surface Area in² [mm²]
- A_i = $b(a - b) + \pi \frac{b^2}{4}$ = Duct Cross Sectional Area, in² [mm²]
- a = Overall width, inside any insulation, in [mm]
- b = Overall height, inside any insulation, in [mm]
- L = Length, in [mm]
- L_{wi} = Sound power level at inlet, dB
- L_{wo} = Sound power level at outlet, dB
- TL_{out} = Transmission loss, dB

NOTE: a, b & L must be in the same units

Values of TL_{out} for flat oval duct are given in Table D5.

Calculation procedure reprinted with permission of the American Society of Heating, Refrigerating & Air Conditioning Engineers, 2007 ASHRAE Handbook, HVAC Applications, Chapter 47.

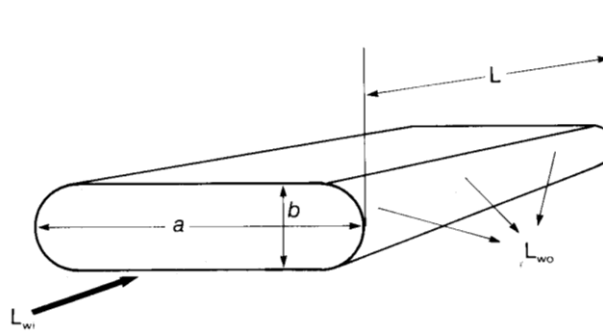

Figure D3. Flat Oval Duct Breakout

D1.2.4 Rectangular Sheet Metal Duct, Lined & Unlined ∇B . Duct Breakout can be calculated from 2007 ASHRAE Handbook, HVAC Applications, Chapter 47 (see Figure D4.).

$$\nabla B = TL_{out} - 10 \log (A_r/A_i) = L_{wi} - L_{wo}$$

Where:

- A_r = $2L (a+b)$, in² [mm²]
- A_i = $a \cdot b$, in² [mm²]
- a = Overall width, inside any insulation, in [mm]
- b = Overall height, inside any insulation, in [mm]
- L = Length, in [mm]
- L_{wi} = Sound Power Level at duct inlet, dB
- L_{wo} = Sound Power Level, dB
- TL_{out} = Transmission loss, dB

NOTE: a, b & L must be in the same units

Values for TL_{out} for rectangular ducts are given in Table D6.

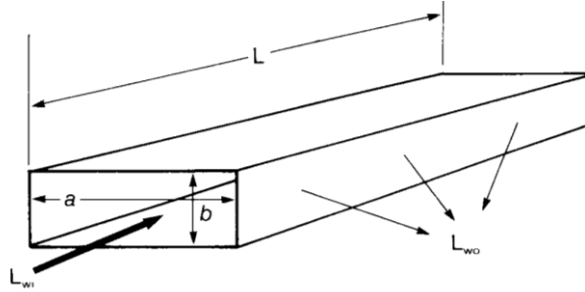

Figure D4. Rectangular Duct Breakout

Calculation procedure reprinted with permission of the American Society of Heating, Refrigerating & Air Conditioning Engineers, 2007 ASHRAE Handbook, Applications Chapter 47.

D1.3 Duct Insertion Loss. As sound travels down a duct, some acoustic energy is absorbed by the duct or its lining, or it is radiated by the duct walls. The result is that the acoustic energy at the end of a section of duct is less than at the entrance.

Table D5. TL_{out} versus Frequency for Flat-Oval Ducts (Ref: D1.2.3), dB										
Overall Dimensions	Duct Size [a x b]	Thickness	Octave Band Mid Frequency, Hz							
			63	125	250	500	1000	2000	4000	8000
In	[mm]	in [mm]								
12 x 6	[300 x 150]	0.028 [0.70]	31	34	37	40	43	33*	33*	33*
24 x 6	[600 x 150]	0.028 [0.70]	24	27	30	33	36	26*	26*	26*
24 x 12	[600 x 300]	0.028 [0.70]	28	31	34	37	27*	27*	27*	27*
48 x 12	[1200 x 300]	0.034 [0.85]	23	26	29	32	22*	22*	22*	22*
48 x 24	[1200 x 600]	0.034 [0.85]	27	30	33	23*	23*	23*	23*	23*
96 x 24	[2400 x 600]	0.044 [1.00]	22	25	28	18*	18*	18*	18*	18*
96 x 48	[2400 x 1200]	0.054 [1.30]	28	31	21*	21*	21*	21*	21*	21*

NOTE: The data are from tests on 20 ft [6 m] long ducts, but the TL values are for ducts of the cross section shown regardless of length.
 * These are estimated values.

Reprinted with permission of the American Society of Heating, Refrigerating and Air Conditioning Engineers, 2007 ASHRAE Handbook, HVAC Applications, Chapter 47, Table 27.

Table D6. TL _{out} versus Frequency for Rectangular Ducts (Ref: D1.2.4), dB										
Overall Dimensions	Duct Size [a x b]	Thickness	Octave Band Mid Frequency, Hz							
In	[mm]	in [mm]	63	125	250	500	1000	2000	4000	8000
12 x 12	[300 x 300]	0.028 [0.70]	21	24	27	30	33	36	41	45
12 x 24	[300 x 600]	0.028 [0.70]	19	22	25	28	31	35	41	45
12 x 48	[300 x 1200]	0.034 [0.85]	19	22	25	28	31	37	43	45
24 x 24	[600 x 600]	0.034 [0.85]	20	23	26	29	32	37	43	45
24 x 48	[600 x 1200]	0.044 [1.00]	20	23	26	29	31	39	45	45
48 x 48	[1200 x 1200]	0.054 [1.30]	21	24	27	30	35	41	45	45
48 x 96	[1200 x 2400]	0.054 [1.30]	19	22	25	29	35	41	45	45

NOTE: The data are from tests on 20 ft [6 m] long ducts, but the TL values are for ducts of the cross section shown regardless of length.

Reprinted with permission of the American Society of Heating, Refrigerating and Air Conditioning Engineers, 2007 ASHRAE Handbook, HVAC Applications, Chapter 47, Table 25.

The factors for determining the loss of acoustic energy are dependent on the lining, if any, and the type and geometry. Duct factors are provided for most types of duct construction.

Due to lack of documented data, this standard makes the assumption that the Insertion Loss of any practical length of unlined sheet metal duct is negligible.

D1.3.1 Lined Circular Sheet Metal Duct Insertion Loss ∇_I Loss

$$\nabla_I = A_s L = L_{wi} - L_{wo}$$

Where:

- A_s = Attenuation, dB/ft [dB/m]
- L = length, ft [m]

(See Figure D5.)

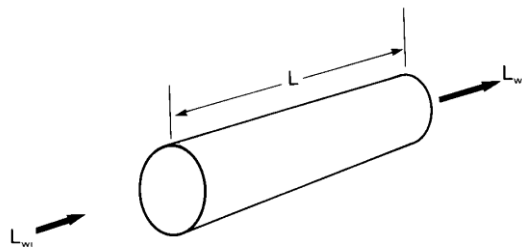

Figure D5. Lined Circular Duct Insertion Loss

D1.3.2 Lined Rectangular or Square Sheet Metal Duct ∇_I . Table D8 shall be used to determine the lined sheet metal Insertion Loss/attenuation for 1.0 in [25 mm] lining. The equation shown in Table D8 shall be used for other lining dimensions.

Table D7. Insertion Loss for Lined Circular Ducts, dB/ft [dB/m]

Insertion Loss for Acoustically Lined Circular Ducts with 1.0 in [25 mm] Lining									Insertion Loss for Acoustically Lined Circular Ducts with 2.0 in [51 mm] Lining								
Octave Band Mid Frequency, Hz									Octave Band Mid Frequency, Hz								
Diameter, In [mm]	63	125	250	500	1000	2000	4000	8000	Diameter, in [mm]	63	125	250	500	1000	2000	4000	8000
6.0 [150]	0.38	0.59	0.93	1.53	2.17	2.31	2.04	1.26	6.0 [150]	0.56	0.80	1.37	2.25	2.17	2.31	2.04	1.26
8.0 [200]	0.32	0.54	0.89	1.50	2.19	2.17	1.83	1.18	8.0 [200]	0.51	0.75	0.33	2.23	2.19	2.17	1.83	1.18
10.0 [250]	0.27	0.50	0.85	1.48	2.20	2.04	1.64	1.12	10.0 [250]	0.46	0.71	0.29	2.20	2.20	2.04	1.64	1.12
12.0 [300]	0.23	0.46	0.81	1.45	2.18	1.91	1.48	1.05	12.0 [300]	0.42	0.67	1.25	2.18	2.18	1.91	1.48	1.05
14.0 [355]	0.19	0.42	0.77	1.43	2.14	1.79	1.34	1.00	14.0 [355]	0.38	0.63	1.21	2.15	2.14	1.79	1.34	1.00
16.0 [410]	0.16	0.38	0.73	1.40	2.08	1.67	1.21	0.95	16.0 [410]	0.35	0.59	1.17	2.12	2.08	1.67	1.21	0.95
18.0 [460]	0.13	0.35	0.69	1.37	2.01	1.56	1.10	0.90	18.0 [460]	0.32	0.56	1.13	2.10	2.01	1.56	1.10	0.90
20.0 [510]	0.11	0.31	0.65	1.34	1.92	1.45	1.00	0.87	20.0 [510]	0.29	0.52	1.09	2.07	1.92	1.45	1.00	0.87
22.0 [560]	0.08	0.28	0.61	1.31	1.82	1.34	0.92	0.83	22.0 [560]	0.27	0.49	1.05	2.03	1.82	1.34	0.92	0.83
24.0 [610]	0.07	0.25	0.57	1.28	1.71	1.24	0.85	0.80	24.0 [610]	0.25	0.46	1.01	2.00	1.71	1.24	0.85	0.80
26.0 [660]	0.05	0.22	0.53	1.24	1.59	1.14	0.79	0.77	26.0 [660]	0.24	0.43	0.97	1.96	1.59	1.14	0.79	0.77
28.0 [710]	0.03	0.19	0.49	1.20	1.46	1.04	0.74	0.74	28.0 [710]	0.22	0.40	0.93	1.93	1.46	1.04	0.74	0.74
30.0 [760]	0.02	0.16	0.45	1.16	1.33	0.95	0.69	0.71	30.0 [760]	0.21	0.37	0.90	1.88	1.33	0.95	0.69	0.71
32.0 [820]	0.01	0.14	0.42	1.12	1.20	0.87	0.66	0.69	32.0 [820]	0.20	0.34	0.86	1.84	1.20	0.87	0.66	0.69
34.0 [865]	0	0.11	0.38	1.07	1.07	0.79	0.63	0.66	34.0 [865]	0.19	0.32	0.82	1.79	1.07	0.79	0.63	0.66
36.0 [910]	0	0.08	0.35	1.02	0.93	0.71	0.60	0.64	36.0 [910]	0.18	0.29	0.79	1.74	0.93	0.71	0.60	0.64
38.0 [965]	0	0.06	0.31	0.96	0.80	0.64	0.58	0.61	38.0 [965]	0.17	0.27	0.76	1.69	0.80	0.64	0.58	0.61
40.0 [1020]	0	0.03	0.28	0.91	0.68	0.57	0.55	0.58	40.0 [1020]	0.16	0.24	0.73	1.63	0.68	0.57	0.55	0.58
42.0 [1070]	0	0.01	0.25	0.84	0.56	0.50	0.53	0.55	42.0 [1070]	0.15	0.22	0.70	1.57	0.56	0.50	0.53	0.55
44.0 [1120]	0	0	0.23	0.78	0.45	0.44	0.51	0.52	44.0 [1120]	0.13	0.20	0.67	1.50	0.45	0.44	0.51	0.52
46.0 [1170]	0	0	0.20	0.71	0.35	0.39	0.48	0.48	46.0 [1170]	0.12	0.17	0.64	1.43	0.35	0.39	0.48	0.48
48.0 [1220]	0	0	0.18	0.63	0.26	0.34	0.45	0.44	48.0 [1220]	0.11	0.15	0.62	1.36	0.26	0.34	0.45	0.44
50.0 [1270]	0	0	0.15	0.55	0.19	0.29	0.41	0.40	50.0 [1270]	0.09	0.12	0.60	1.28	0.19	0.29	0.41	0.40
52.0 [1320]	0	0	0.14	0.46	0.13	0.25	0.37	0.34	52.0 [1320]	0.07	0.10	0.58	1.19	0.13	0.25	0.37	0.34
54.0 [1370]	0	0	0.12	0.37	0.09	0.22	0.31	0.29	54.0 [1370]	0.05	0.08	0.56	1.10	0.09	0.22	0.31	0.29
56.0 [1420]	0	0	0.10	0.28	0.08	0.18	0.25	0.22	56.0 [1420]	0.02	0.05	0.55	1.00	0.08	0.18	0.25	0.22
58.0 [1470]	0	0	0.09	0.17	0.08	0.16	0.18	0.15	58.0 [1470]	0	0.03	0.53	0.90	0.08	0.16	0.18	0.15
60.0 [1520]	0	0	0.08	0.06	0.10	0.14	0.09	0.07	60.0 [1520]	0	0	0.53	0.79	0.10	0.14	0.09	0.07

Because of structure, home borne sound that is transmitted through the duct wall, the attenuation usually does not exceed 40 dB.

Reprinted with permission of the American Society of Heating, Refrigerating and Air Conditioning Engineers. 2007 ASHRAE Handbook, HVAC Applications, Chapter 47, Tables 15 and 16.

Table D8. Sound Insertion Loss/Attenuation in Straight Lined Sheet Metal Ducts of Rectangular Cross-Section in dB/ft [dB/0.3 m] Lining Thickness: 1.0 in [25 mm]: No Airflow, dB/ft [dB/m]

Internal Cross-Sectional Dimensions		Octave Band Center Frequency, Hz						
In	[mm]	125	250	500	1000	2000	4000	8000
6.0 x 6.0	150 x 150	0.6	1.5	2.7	5.8	7.4	4.3	2.0
6.0 x 10.0	150 x 250	0.5	1.2	2.4	5.1	6.1	3.7	1.9
6.0 x 12.0	150 x 300	0.5	1.2	2.3	5.0	5.8	3.6	1.9
6.0 x 18.0	150 x 460	0.5	1.0	2.2	4.7	5.2	3.3	1.9
8.0 x 8.0	200 x 200	0.5	1.2	2.3	5.0	5.8	3.6	1.9
8.0 x 12.0	200 x 300	0.4	1.0	2.1	4.5	4.9	3.2	1.8
8.0 x 16.0	200 x 410	0.4	0.9	2.0	4.3	4.5	3.0	1.8
8.0 x 24.0	200 x 610	0.4	0.8	1.9	4.0	4.1	2.8	1.8
10.0 x 10.0	250 x 250	0.4	1.0	2.1	4.4	4.7	3.1	1.8
10.0 x 16.0	250 x 410	0.4	0.8	1.9	4.0	4.0	2.7	1.8
10.0 x 20.0	250 x 510	0.3	0.8	1.8	3.8	3.7	2.6	1.7
10.0 x 30.0	250 x 760	0.3	0.7	1.7	3.6	3.3	2.4	1.7
12.0 x 12.0	300 x 300	0.4	0.8	1.9	4.0	4.1	2.8	1.8
12.0 x 18.0	300 x 460	0.3	0.7	1.7	3.7	3.5	2.5	1.7
12.0 x 24.0	300 x 610	0.3	0.6	1.7	3.5	3.2	2.3	1.7
12.0 x 36.0	300 x 910	0.3	0.6	1.6	3.3	2.9	2.2	1.7
15.0 x 15.0	380 x 380	0.3	0.7	1.7	3.6	3.3	2.4	1.7
15.0 x 22.0	380 x 560	0.3	0.6	1.6	3.3	2.9	2.2	1.7
15.0 x 30.0	380 x 760	0.3	0.5	1.5	3.1	2.6	2.0	1.6
15.0 x 45.0	380 x 1140	0.2	0.5	1.4	2.9	2.4	1.9	1.6
18.0 x 18.0	460 x 460	0.3	0.6	1.6	3.3	2.9	2.2	1.7
18.0 x 28.0	460 x 710	0.2	0.5	1.4	3.0	2.4	1.9	1.6
18.0 x 36.0	460 x 910	0.2	0.5	1.4	2.8	2.2	1.8	1.6
18.0 x 54.0	460 x 1370	0.2	0.4	1.3	2.7	2.0	1.7	1.6
24.0 x 24.0	610 x 610	0.2	0.5	1.4	2.8	2.2	1.8	1.6
24.0 x 36.0	610 x 910	0.2	0.4	1.2	2.6	1.9	1.6	1.5
24.0 x 48.0	610 x 1220	0.2	0.4	1.2	2.4	1.7	1.5	1.5
24.0 x 72.0	610 x 1830	0.2	0.3	1.1	2.3	1.6	1.4	1.5
30.0 x 30.0	760 x 760	0.2	0.4	1.2	2.5	1.8	1.6	1.5
30.0 x 45.0	760 x 1140	0.2	0.3	1.1	2.3	1.6	1.4	1.5
30.0 x 60.0	760 x 1520	0.2	0.3	1.1	2.2	1.4	1.3	1.5
30.0 x 90.0	760 x 2290	0.1	0.3	1.0	2.1	1.3	1.2	1.4
36.0 x 36.0	910 x 910	0.2	0.3	1.1	2.3	1.6	1.4	1.5
36.0 x 54.0	910 x 1370	0.1	0.3	1.0	2.1	1.3	1.2	1.4
36.0 x 72.0	910 x 1830	0.1	0.3	1.0	2.0	1.2	1.2	1.4
36.0 x 108.0	910 x 2740	0.1	0.2	0.9	1.9	1.1	1.1	1.4
42.0 x 42.0	1070 x 1070	0.2	0.3	1.0	2.1	1.4	1.3	1.4
42.0 x 64.0	1070 x 1630	0.1	0.3	0.9	1.9	1.2	1.1	1.4
42.0 x 84.0	1070 x 2130	0.1	0.2	0.9	1.8	1.1	1.1	1.4
42.0 x 126.0	1070 x 3200	0.1	0.2	0.9	1.7	1.0	1.0	1.4
48.0 x 48.0	1220 x 1220	0.1	0.3	1.0	2.0	1.2	1.2	1.4
48.0 x 72.0	1220 x 1830	0.1	0.2	0.9	1.8	1.0	1.0	1.4
48.0 x 96.0	1220 x 2440	0.1	0.2	0.8	1.7	1.0	1.0	1.3
48.0 x 144.0	1220 x 3660	0.1	0.2	0.8	1.6	0.9	0.9	1.3

Based on measurements of surface-coated duct liners of 1.5 lb/ft³ [24 kg/m³] density. Liner density has a minor effect over the range of 1.5 to 3.0 lb/ft³ [24 to 48 kg/m³].

$$I = \text{Insertion Loss/Attenuation} = 10^{\text{Coeff A}} \cdot (P/A)^{\text{Coeff B}} \cdot t^{\text{Coeff C}}$$

Where: P/A = Perimeter/Area, 1/ft and t = thickness, in

Coefficients	Octave Band Center Frequency, Hz	125	250	500	1000	2000	4000	8000
	Coeff A	-0.865	-0.582	-0.0121	0.298	0.089	0.0649	0.15
	Coeff B	0.723	0.826	0.487	0.513	0.862	0.629	0.166
	Coeff C	0.375	0.975	0.868	0.317	0	0	0

Reprinted with permission of the American Society of Heating, Refrigerating and Air Conditioning Engineers, 2007 ASHRAE Handbook, HVAC Applications, Chapter 47, Table 12.

D1.3.3 Lined Flexible Duct Insertion Loss  . Table D9 can be used to determine the nonmetal flexible duct Insertion Loss. (See Figure D6.)

D1.3.3.1 Unlined Flexible Duct Insertion Loss. For purposes of this Standard, unlined flexible duct is conservatively modeled as unlined hard duct due to lack of existing data substantiating any differences.

Table D9. Lined Flexible Duct Insertion Loss, dB

Duct Diameter in [mm]	Length L ft [m]	Insertion Loss, dB - Octave Band Mid Frequency, Hz							
		63	125	250	500	1000	2000	4000	8000
4 [100]	10 [3]	8	9	9	27	32	38	24	17
	5.0 [1.5]	4	6	5	16	23	27	18	11
	3 [0.9]	3	4	4	12	19	23	15	9
5 [125]	10 [3]	8	9	12	28	32	37	23	15
	5.0 [1.5]	4	5	7	17	22	25	16	10
	3 [0.9]	3	4	5	13	18	21	13	8
6 [150]	10 [3]	8	9	15	28	32	35	22	13
	5.0 [1.5]	4	5	9	18	21	24	15	9
	3 [0.9]	3	4	6	13	16	19	11	7
7 [175]	10 [3]	8	9	16	29	32	34	21	12
	5.0 [1.5]	4	5	10	18	20	22	13	8
	3 [0.9]	3	4	7	14	15	17	10	6
8 [200]	10 [3]	8	9	18	29	31	32	20	10
	5.0 [1.5]	4	5	10	18	19	21	12	7
	3 [0.9]	2	3	7	14	14	16	8	6
9 [225]	10 [3]	8	8	18	28	31	31	19	9
	5.0 [1.5]	4	5	11	18	18	19	10	6
	3 [0.9]	2	3	8	14	12	14	7	5
10 [250]	10 [3]	7	8	19	28	30	29	18	8
	5.0 [1.5]	3	4	11	18	17	18	9	5
	3 [0.9]	2	3	7	14	11	13	6	4
12 [300]	10 [3]	6	7	17	26	28	26	15	7
	5.0 [1.5]	3	3	9	16	15	15	7	4
	3 [0.9]	1	2	6	12	9	11	4	3
14 [350]	10 [3]	4	5	13	23	25	23	12	6
	5.0 [1.5]	2	2	7	14	13	13	6	4
	3 [0.9]	1	1	4	10	8	9	4	3
16 [400]	10 [3]	2	3	7	19	23	20	8	6
	5.0 [1.5]	0	1	2	11	11	11	5	3
	3 [0.9]	0	0	0	8	7	8	4	2

Data based on solid core (non-perforated or woven), 1.0 in [25 mm] thickness insulation, and plastic jacket.

This data is compiled from several sources and should therefore be used as a guide.

$$IL, \text{ by Band} = (C1 + C2 \cdot D + C3 \cdot D^2) + ((C4 + C5 \cdot D + C6 \cdot D^2) \cdot L) \text{ Where } D = \text{in and } L = \text{ft}$$

Coefficients	Band	63	125	250	500	1000	2000	4000	8000
	C1	1	2.601	-2.023119	1.533116	23.452	26.15493	25.06003	10.03558
	C2	-0.05	-0.125061	1.276239	1.407587	-2.844882	-2.885191	-4.0431	-1.104969
	C3	-0.006339	0.006339	-0.082116	-0.083166	0.0851754	0.0884209	0.1626905	0.0338121
	C4	0.48	0.4852413	-0.691433	1.948206	0.8380425	1.702466	0.2239686	1.504462
	C5	0.0757873	0.07757873	0.4378392	0.0627173	0.3254958	0.1615714	0.344374	-0.133883
	C6	-0.005221	-0.005221	-0.020816	-0.005056	-0.014685	-0.009956	-0.020039	0.0043834

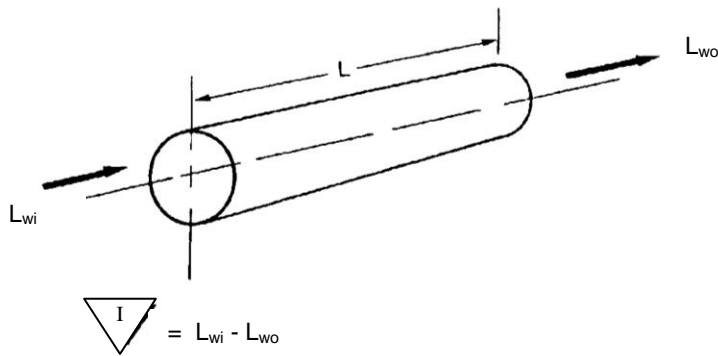

Figure D6. Lined Flexible Duct Insertion Loss

D1.3.3.2 Lined Flexible Duct Insertion Loss.

D1.4 Round and Rectangular Duct Elbow and Tee ∇T Loss . Little data is available on the attenuation at branch takeoffs, and data available on the attenuation of elbows is based on limited testing. (Reference 2003 ASHRAE Handbook, HVAC Applications, Chapter 47.) (See Figure D7.)

D1.4.1 Round Lined Duct – 90° Elbows. Table D10 presents empirical data on the attenuation provided by duct elbows in lined duct systems.

D1.4.2 Round Unlined Duct – 90° ∇T Elbows . The Insertion Loss of 90° round unlined elbows is minimal (see Table D11).

Table D10. Attenuation of Lined Round Elbows When Preceding and Following at Least 3 Lined Duct Diameters of Duct Lining, dB									
Diameter		Octave Band Mid Frequency, Hz							
In	[mm]	63	125	250	500	1000	2000	4000	8000
5 to 10	[125 to 250]	0	0	0	1	2	3	3	3
11 to 20	[260 to 510]	0	1	2	2	3	3	3	3
21 to 40	[520 to 1020]	0	2	2	3	3	3	3	3
41 to 80	[1030 to 2030]	1	2	3	3	3	3	3	3

D1.4.3 Rectangular Square Elbows Either Mitered or Without Turning Vanes, Lined and Unlined ∇T . The approximate values for attenuation, as listed in earlier references, are provided in Table D12.

D1.4.4 Rectangular Tee ∇T Loss . With respect to sound attenuation performance, unlined tee fittings can be treated on the basis of two similar 90° elbows. See D1.1 for additional branch power division. (See Figure D7.)

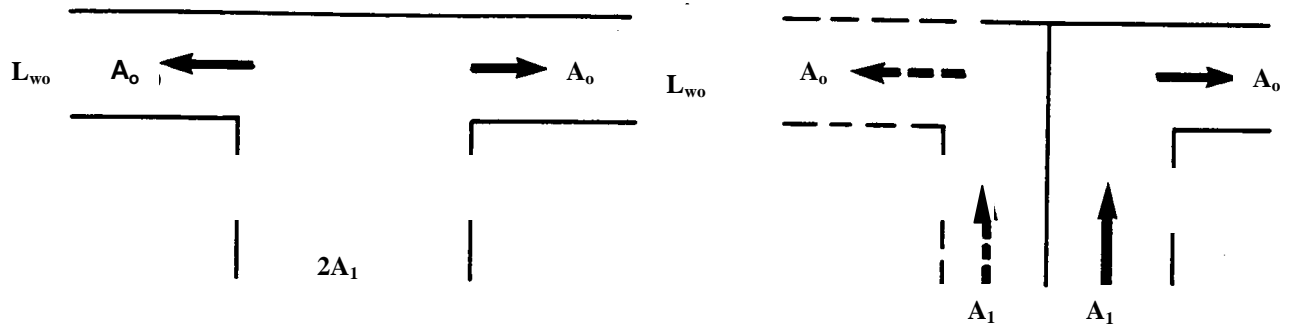

$$\nabla T = L_{wi} - L_{wo}$$

Where: ∇T is from elbow data, Table D12.

A_1 = inlet area
 A_0 = outlet area

Figure D7. Duct Elbow and Tee Loss

Table D11. Insertion Loss of Round Elbows, Radiused Elbow 90°, dB									
Diameter		Octave Band Mid Frequency, Hz							
In	[mm]	63	125	250	500	1000	2000	4000	8000
5 - 10	[100 - 250]	0	0	0	1	2	3	3	3
11 - 20	[260 - 700]	0	1	2	2	3	3	3	3
21 - 40	[710 - 1000]	0	2	2	3	3	3	3	3
41 - 80	[1010 - 2000]	1	2	3	3	3	3	3	3

From ASHRAE Applications Handbook, 2007, Chapter 47, Table 18

Table D12. Insertion Loss of Unlined and lined Elbows Without Turning Vanes, dB									
From ASHRAE Applications Handbook, 2007, Chapter 47, Table 17									
Width		Octave Band Mid Frequency, Hz							
In	mm	63	125	250	500	1000	2000	4000	8000
Unlined Duct									
5-10	[100 - 125]	0	0	0	1	5	8	4	3
11-20	[260 - 700]	0	1	5	5	8	4	3	3
21-40	[710 - 1000]	0	5	5	8	4	3	3	3
41-80	[1010 - 2000]	1	5	8	4	3	3	3	3
Lined Duct									
5-10	[100 - 250]	0	0	0	1	6	11	10	10
11-20	[260 - 700]	0	1	6	6	11	10	10	10
21-40	[710 - 1000]	0	6	6	11	10	10	10	10
41-80	[1010 - 2000]	1	6	11	10	10	10	10	10
Insertion Loss of Unlined and Lined Elbows With Turning Vanes, dB									
From ASHRAE Applications Handbook, 2007, Chapter 47, Table 19									
Unlined Duct									
5-10	[100 - 250]	0	0	0	1	4	6	4	4
11-20	[260 - 700]	0	1	4	6	4	4	4	4
21-40	[710 - 1000]	0	4	6	6	4	4	4	4
41-80	[1010 - 2000]	1	4	6	6	4	4	4	4
Lined Duct									
5-10	[100 - 250]	0	0	0	1	4	7	7	7
11-20	[260 - 700]	0	1	4	7	7	7	7	7
21-40	[710 - 1000]	0	4	7	7	7	7	7	7
41-80	[1010 - 2000]	1	4	7	7	7	7	7	7

D1.5 *End Reflection Factor*  . When plane wave sound passes from a small space such as a duct into a large space the size of a room, a certain amount of sound is reflected back into the duct, significantly reducing low frequency sound. See Table D13. While the values of Table D13 apply to straight runs of duct entering a room, caution should be exercised when a condition differs drastically from the test condition. Discharge sound power data measured in accordance with AHRI Standard 880 already includes one end reflection resulting from the test setup. This procedure is based on research conducted under ASHRAE Research Project RP-1314.

Table D13. End Reflection Loss/Per ASHRAE RP 1314, dB

Duct Diameter		Octave Band Mid Frequency, Hz						
In	[mm]	63	125	250	500	1000	2000	4000
6	[150]	18	12	7	3	1	0	0
8	[200]	16	10	5	2	1	0	0
10	[250]	14	8	4	1	0	0	0
12	[300]	12	7	3	1	0	0	0
16	[400]	10	5	2	1	0	0	0
20	[500]	8	4	1	0	0	0	0
24	[600]	7	3	1	0	0	0	0
28	[700]	6	2	1	0	0	0	0
32	[800]	5	2	1	0	0	0	0
36	[900]	4	2	0	0	0	0	0
48	[1200]	3	1	0	0	0	0	0
72	[1800]	2	0	0	0	0	0	0

ERL (From ASHRAE RP 1314) $ERL = 10 \cdot \log (1 + (a_1 \cdot c/Pi \cdot f \cdot (D/12))^a)$

Where:

C_o	1127
Pi	3.14159
a_1	0.7
a_2	2
f	Hz

Speed of sound, ft/s

a_1 , flush – Terminated duct, pink noise, full octave

a_2 , flush – Terminated duct, pink noise, full octave, rounded D in inches

octave band center frequency

D1.6 Ceiling/Space Effect  . To calculate the sound level in a space resulting from a sound source located in the ceiling cavity, a transfer function is provided which is used to calculate the sound pressure in the space, when used with the Environment Adjustment Factor. This transfer function includes the combined effect of the absorption of the ceiling tile, plenum absorption and room absorption. This procedure is based on research conducted under ASHRAE Research Project RP-755.

The procedure assumes the following conditions:

- a. The plenum is at least 3 ft [0.9 m] deep.
- b. The plenum space is either wide (over 30 ft [9 m]) or lined with insulation.
- c. The ceiling has no significant penetrations directly under the unit.

For conditions other than these, sound transfer functions may be less. For instance, in a shallow plenum, 2 ft [0.6 m] deep or less, tests have shown that the sound in the space can be expected to be 5-7 dB louder below 500 Hz. Each category represents an average set of transmission loss values that had a small variation as a function of material thickness and density. In general, the transmission loss properties of ceiling tile or gypsum board ceiling above 250 Hz depends on the mass per unit area of the material. Below 250 Hz, stiffness has a stronger influence.

An insertion loss test wherein sound pressure in the space with and without ceiling tiles is compared, is not recommended, and was shown in the RP-755 research project to yield data which is not of use in room sound analysis or prediction. An example of the calculation of the total transfer function for three different sized Air Terminals is provided below in Table D14.

Table D14. Uncorrected Ceiling/Space Effect Attenuation Values, dB

Type #	Tile Type	Density		Thickness		Weight		Octave Band Mid Frequency, Hz						
		lb/ft ³	[kg/m ³]	in	[mm]	lb/ft ²	[kg/m ²]	63	125	250	500	1000	2000	4000
1	Mineral Fiber	20	[300]	0.63	[16]	1	[5]	13	16	18	20	26	31	36
2	Mineral Fiber	10	[160]	0.63	[16]	0.50	[2.5]	13	15	17	19	25	30	33
3	Glass Fiber	3	[40]	0.63	[16]	0.1	[0.7]	13	16	15	17	17	18	19
4	Glass Fiber	4	[60]	1.97	[50.0]	0.6	[3]	14	17	18	21	25	29	35
5	Glass Fiber, TL Backed	4	[60]	1.97	[50.0]	0.6	[3]	14	17	18	22	27	32	39
6	Gypsum Board Tiles	43	[690]	0.51	[13]	1.8	[9.0]	14	16	18	18	21	22	22
7	Solid Gypsum Board	43	[690]	0.51	[13]	1.8	[9.0]	18	21	25	25	27	27	28
8	Solid Gypsum Board	43	[690]	0.63	[16]	2.2	[11]	20	23	27	27	29	29	30
9	Double Gypsum Board	45	[700]	0.98	[25]	3.7	[18]	24	27	31	31	33	33	34
10	Double Gypsum Board	43	[690]	1.26	[32.0]	4.5	[22]	26	29	33	33	35	35	36
11	Concealed Spline	20	[300]	0.63	[16]	1	[5]	20	23	21	24	29	33	34

Data from ASHRAE Applications Handbook, 2007, Chapter 47, Table 28

For spaces with no ceiling, the sound attenuation of radiated sound should be calculated using the equation for Table D16 employing room volume and distance to the sound source, as if the source were a point source. Be sure to include the total volume of the space including the region where the source is located.

D1.7 Space Effect . A sound source terminating in the occupied space is assumed to be a point source. The calculation of the Sound Pressure Level, L_p in rooms for the entering sound power L_w can be accomplished using the Schultz equation:

$$L_p = L_w - 10 \log r - 5 \log V - 3 \log f + 25$$

Where:

- f = Octave band mid frequency of interest, Hz
- L_p = Sound Pressure Level in dB re $10\mu\text{Pa}$
- L_w = Sound Power Level in dB re 1 Pw
- r = Shortest distance from noise source to the receiver, ft [m]
- V = Room volume, ft³ [m³]

Table D15. Ceiling/Space Effect Examples, dB							
	Octave Band Mid Frequency, Hz						
	63	125	250	500	1000	2000	4000
Type 1, Mineral Tile	13	16	18	20	26	31	36
Environmental Effect	4	2	1	0	0	0	0
Total deduct from Sound Power	17	18	19	20	26	31	36
Type 4, Glass Fiber	14	17	18	21	25	29	35
Environmental Effect	4	2	1	0	0	0	0
Total deduct from Sound Power	18	19	19	21	25	29	35
Type 7, Solid Gypsum Board	18	21	25	25	27	27	28
Environmental Effect	4	2	1	0	0	0	0
Total deduct from Sound Power	22	23	26	25	27	27	28

Note: Data is seldom available in the 63 Hz octave band for Air Terminals, and is therefore seldom used in room Sound Pressure estimations for these devices. Studies have shown that sound levels for these devices are rarely critical in the 63 Hz Octave Band.

Table D16. Space Effect, Point Source, dB									
		Octave Band Mid Frequency, Hz							
Room Volume	Distance	63	125	250	500	1000	2000	4000	8000
2000 ft ³ [60 m ³]	5.0 ft [1.5 m]	-4	-5	-6	-7	-7	-8	-9	-10
	10 ft [3 m]	-7	-8	-9	-10	-11	-11	-12	-13
	15 ft [4.6 m]	-9	-10	-10	-11	-12	-13	-14	-15
2500 ft ³ [69 m ³]	5.0 ft [1.5 m]	-4	-5	-6	-7	-8	-9	-10	-11
	10 ft [3 m]	-7	-8	-9	-10	-11	-12	-13	-14
	15 ft [4.6 m]	-9	-10	-11	-12	-13	-14	-14	-15
3000 ft ³ [80 m ³]	5.0 ft [1.5 m]	-5	-6	-7	-7	-8	-9	-10	-11
	10 ft [3 m]	-8	-9	-10	-10	-11	-12	-13	-14
	15 ft [4.6 m]	-10	-10	-11	-12	-13	-14	-15	-16
5000 ft ³ [100 m ³]	5.0 ft [1.5 m]	-6	-7	-8	-9	-9	-10	-11	-12
	10 ft [3 m]	-9	-10	-11	-12	-12	-13	-14	-15
	15 ft [4.6 m]	-11	-12	-12	-13	-14	-15	-16	-17

Table D16 is to be used for a single sound source in the room. This includes a diffuser, and is also valid for computing the sound traveling from an Air Terminal through the supply ductwork and entering the room through the diffuser. The sound generated by the diffuser and the Air Terminal sound transmitted through the diffuser should be logarithmically added in a manner similar to Table 9.

The term ($L_w - L_p$) can be thought of as the effect of the space upon the entering sound power producing the resulting sound pressure level.

Thus:

$$\nabla S = L_w - L_p = \text{Space Effect}$$

$$\nabla S = 10 \log r + 5 \log V + 3 \log f \text{ (Hz)} - 25$$

$$S_A = L_w - L_p = \text{Distributed Ceiling Array Space Effect}$$

Where:

- f = Octave-band mid frequency in Hz
- h = Ceiling height, ft [m]
- N = Number of evenly spaced outlets in the room, minimum four
- S_A = 5 log x + 28 log h - 1.13 log N + 3 log f - 31 dB
- x = Ratio of the floor area served by each outlet to the square of the ceiling height, ft [m]

D1.8 *Distributed Array* ∇S_2 . For the special case of a distributed ceiling array of air outlets where all of the sources have the same L_w, the space effect can be calculated from:

This data is presented for an array of four outlets for four different room heights, three different outlet areas, in Table D17.

D1.9 *Discharge Sound Example Calculations.* Calculations can be made for some standard conditions, for use as typical sound attenuation values (see Appendix E). Calculations for a typical Air Terminal are determined for three sizes of units, as indicated.

Table D17. Room Sound Attenuation for an Outlet Array, 4 Outlets, dB									
Area/Diffuser	Ceiling Height	Octave Band Mid Frequency, Hz							
		63	125	250	500	1000	2000	4000	8000
200 ft ² [20 m ²] 300 ft ² [30 m ²] 400 ft ² [40 m ²]	8 ft [2 m]	1	2	3	4	5	6	7	8
200 ft ² [20 m ²] 300 ft ² [30 m ²] 400 ft ² [40 m ²]	9 ft [3 m]	2	3	4	5	6	7	8	9
200 ft ² [20 m ²] 300 ft ² [30 m ²] 400 ft ² [40 m ²]	10 ft [3 m]	3	4	5	6	7	8	9	10
200 ft ² [20 m ²] 300 ft ² [30 m ²] 400 ft ² [40 m ²]	12 ft [3.6 m]	5	6	6	7	8	9	10	11

Assumes array of 4 diffusers. This table does not apply for a row of linear diffusers.

Table D18. Discharge Sound Effect Sample Calculations, dB										
Small Box (8 in x 8 in Duct) [(0.2 m x 0.2 m Duct)]		Octave Band Mid Frequency, Hz							< 300 cfm [0.1 m ³ /s]	
		63	125	250	500	1000	2000	4000	8000	
1	Environmental Effect	4	2	1	0	0	0	0	0	Table C1
2	Duct Lining, 8 in x 8 in	0	2	6	12	25	29	18	10	Table D8, 5.0 ft [1.5 m] Duct Lining
3	End Reflection	16	10	5	2	1	0	0	0	Table D13, 8 in [200 mm] Termination
4	5.0 ft [1.5 m], 8 in [200 mm] Flex Duct	4	5	10	18	19	21	12	7	Table D9, Vinyl Core Flex
6	Space Effect	4	5	6	7	8	9	10	11	Table D16, 2400 ft ³ [67 m ³] @ 5.0 ft [1.5 m] Distance
7	Sound Power Division	0	0	0	0	0	0	0	0	10 · Log # Spaces Supplied (1)
Total Attenuation		28	24	28	39	53	59	40	28	
Medium Box (12 in x 12 in Duct) [(0.30 m x 0.30 m Duct)]									300 - 700 cfm [0.1 - 0.3 m ³ /s]	
1	Environmental Effect	4	2	1	0	0	0	0	0	Table C1
2	Duct Lining, 12 in x 12 in	0	2	4	10	20	20	14	9	Table D8, 5.0 ft [1.5 m] Duct Lining
3	End Reflection	16	10	5	2	1	0	0	0	Table D13, 8 in [200 mm] Termination
4	5.0 ft [1.5 m], 8 in [200 mm] Flex Duct	4	5	10	18	19	21	12	7	Table D9, Vinyl Core Flex
6	Space Effect	4	5	6	7	8	9	10	11	Table D16, 2400 ft ³ [67 m ³] @ 5.0 ft [1.5 m] Distance
7	Sound Power Division	3	3	3	3	3	3	3	3	10 · Log # Spaces Supplied (2)
Total Attenuation		31	27	29	40	51	53	39	30	
Large Box (15 in x 15 in Duct) [(0.40 m x 0.40 m Duct)]									> 700 cfm [0.3 m ³ /s]	
1	Environmental Effect	4	2	1	0	0	0	0	0	Table C1
2	Duct Lining, 15 in x 15 in	0	2	3	9	18	17	12	9	Table D8, 5.0 ft [1.5 m] Duct Lining
3	End Reflection	16	10	5	2	1	0	0	0	Table D13, 8 in [200 mm] Termination
4	5.0 ft [1.5 m], 8 in [200 mm] Flex Duct	4	5	10	18	19	21	12	7	Table D9, Vinyl Core Flex

Table D18. Discharge Sound Effect Sample Calculations, dB (continued)									
	63	125	250	500	1000	2000	4000	8000	
6 Space Effect	4	5	6	7	8	9	10	11	Table D16, 2400 ft [67 m ³] @ 5.0 ft [1.5 m] Distance
7 Sound Power Division	5	5	5	5	5	5	5	5	10 · Log # Spaces Supplied (3)
Total Attenuation	33	29	30	41	51	52	39	32	

D1.10 *Manufacturer’s Attenuation Elements* ∇_M . The Insertion Loss of lined boots, attenuators, or other silencing equipment added to the acoustic model should be included in the calculation using manufacturer’s data.

The attachment of a Silencer directly to the discharge of an Air Terminal may result in locally high velocities at the entrance to the device. A partially closed air terminal damper, or a discharge mounted fan, can produce localized high air velocities, resulting in high self generated sound levels, and reducing the effectiveness of the Silencer. A Silencer should be located at least three equivalent diameters downstream of the Air Terminal to avoid this condition.

D1.11 *Air Outlet Sound Estimates.* In order to compare the noise levels of different systems at the design stage where exact room dimensions are not known, the following default room values are suggested.

1. Small Room, Single Outlet 1,500 ft³ [42 m³]
2. Large Room, ≤ four Outlets 8,000 ft³ [200 m³]

It is also recommended that noise level predictions be made at heights 5.0 ft [1.5 m] above the floor when no specific height is specified. (See Figure 12)

In many cases, for outlets, manufacturers publish only a single NC diffuser rating. In this case, a conservative estimate of outlet generated Sound Power Levels can be obtained by assuming the individual octave band Sound Pressure Levels associated with the published NC rating and then adding to these values the manufacturer’s assumed room attenuation to each value.

EXAMPLE:

A diffuser is employed whose published NC rating is 30 based on an assumed 10 dB room absorption. The individual octave band Sound Power Levels can be estimated by Table D19.

Table D19. Air Outlet Sound Estimates, dB							
	Octave Band Mid Frequency, Hz						
	63	125	250	500	1000	2000	4000
Octave Band L _p for NC = 30 (See Table 12)	57	48	41	35	31	29	28
Typical Mfg. Room Attenuation Assumptions	+10	+10	+10	+10	+10	+10	+10
Estimated Outlet Generated L _w	67	58	51	45	41	39	38

For a closer approximation of diffuser sound power when only NC is known, one can assume that the sound power for the diffuser in the 5th octave band (1,000 Hz) is equal to the reported NC plus 10 dB, the 4th band (500 Hz) is 3 greater than this, and the 6th band (2000 Hz) is 5 less. This will be suitable for most applications. This is not applicable for linear diffusers.

APPENDIX E. TYPICAL SOUND ATTENUATION VALUES – NORMATIVE

E1 The following Table E1 values are required for use by manufacturers to calculate NC values for use in catalogs.

In product catalogs the end use environments are not known and the following factors are provided as uniform attenuation values. Use of these values will allow better comparison between manufacturers.

Table E1. Typical Sound Attenuation Values, dB							
Diffusers:							
Deduct 10 dB in all Octave Bands to compute diffuser NC							
VAV Terminals: Radiated Sound Ceiling Plenum Noise Sources: Total deduct from Sound Power to Predict Room Sound Pressure (Includes Environmental Effect), dB							
Assumes, 3 ft [0.9 m] deep plenums with non-bounded sides							
	Octave Band Mid Frequency, Hz						
	125	250	500	1000	2000	4000	
Type - Mineral Fiber	18	19	20	26	31	36	
From Table D15							
VAV Terminals: Discharge Sound, Noise Source in Occupied Space:							
	Octave Band Mid Frequency, Hz						
	125	250	500	1000	2000	4000	8000
Small Box (8 x 8 in) [(0.2 x 0.2 m)] < 300 cfm [$<0.1 \text{ m}^3/\text{s}$]	24	28	39	53	59	40	28
Medium Box (12 x 12 in) [(0.30 x 0.30 m)] 300 - 700 cfm [$0.1 - 0.3 \text{ m}^3/\text{s}$]	27	29	40	51	53	39	30
Large Box (15 x 15 in) [(0.40 x 0.40 m)] > 700 cfm [$0.3 \text{ m}^3/\text{s}$]	29	30	41	51	52	39	32
From Table D18							